

# MC5100

## Series

CVD COATED GRADES  
FOR CAST IRON TURNING

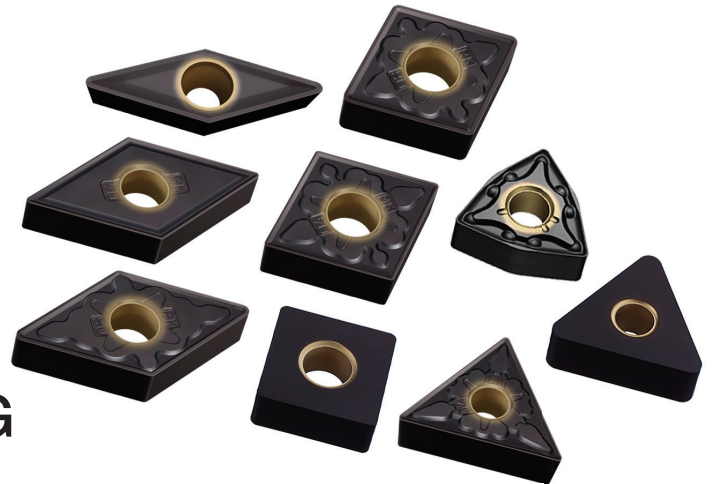

**MC5105 LK**  
**MC5115 + MK**  
**MC5125 RK**

CVD Coated Grades for Cast Iron Turning

# MC5100 Series

**A choice of different grades ideally suited to all types of cast iron machining.**

The process of casting iron enables complex geometries to be formed in the component that is produced. Different types of cast irons produce different chips when machined and can cause various types of damage to an insert. The complex shapes produced in castings also creates challenges when machining and can vary from continuous to interrupted cutting. In response to these challenges, Mitsubishi Materials has created a series of grades that are able to successfully machine all types of cast iron materials and component geometries.

## Chip morphology of cast iron

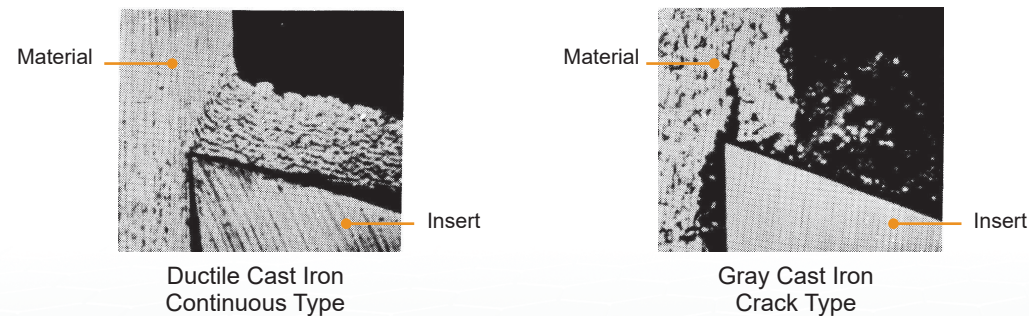

## Features

### "Super" Nano Texture Technology

The standard Nano Texture Technology has been improved and developed to be an industry leading standard for crystal growth of Al<sub>2</sub>O<sub>3</sub> coatings. This Super Nano Texture Technology increases tool life and wear resistance due to the fine, dense crystal growth process.

**MC5100**

Conventional A

**20 times more than conventional B inserts**

Conventional B

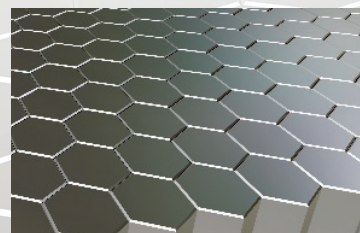

\*By Image

The ratio of Al<sub>2</sub>O<sub>3</sub> crystal grains with the same orientation



Conventional CVD inserts  
Grain size and growth direction are uneven.

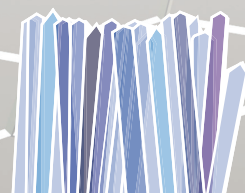

Nano Texture  
Uniformity of the grain size and growth direction has improved.



"Super" Nano Texture  
Uniformity of the growth direction has drastically improved.

Crystal Orientation

For high speed cutting of gray cast iron

## MC5105

**Provides outstanding wear resistance when turning gray cast iron at up to 3280 SFM cutting speeds.**

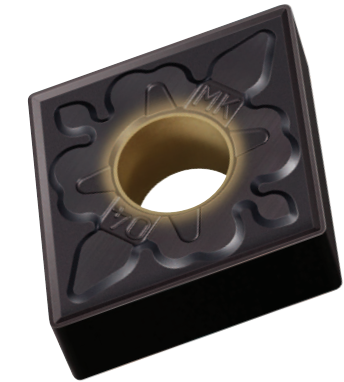

First recommended grade for ductile cast iron

## MC5115

**Prevents abnormal cutting edge damage and displays excellent wear and fracture resistance when machining ductile cast iron.**

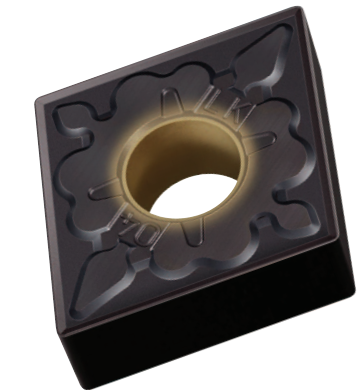

For heavy interrupted cutting of ductile cast iron

## MC5125

**Demonstrates excellent fracture resistance that can withstand heavy interrupted cutting of high strength ductile cast iron.**

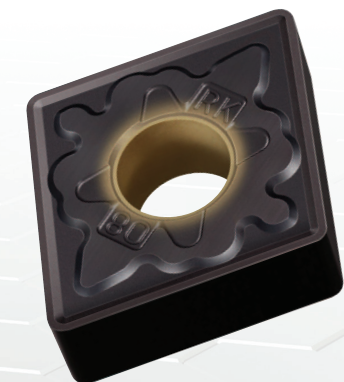

## From the Developers

Since gray cast iron tends to be machined at high speeds (1640-3280 SFM), it is important to make the Al<sub>2</sub>O<sub>3</sub> film coating as strong as possible in order to ensure wear resistance. The focus was on the formation of crystals and the improvement of the intermediate layer of the coating. The coating has also been adjusted to provide excellent intermittent performance despite using a harder carbide substrate compared to conventional products.

Ductile cast iron is machined at relative low speeds (330-985 SFM) and TiCN has a higher hardness. As for the intermittent cutting performance, it was difficult to identify the cause of the edge chipping, but the investigation results revealed that the peeling of the coating was the cause of chipping so a stronger adhesion layer was introduced.

The MC5100 series has been expanded to include grades that are optimal for each type of cast iron turning. These grades will become an indispensable tool for customers that machine cast iron materials.

# Tough and Sub Grip Layers for Ductile Cast Iron Grades

The extra strength of the adhesion between the coating layers (1.3 times stronger) suppresses peeling during machining of ductile cast iron.

**Adhesion is 1.3 Times\* Greater!**

\*Compared with a conventional Mitsubishi product.



**MC5115**

## TOUGH-Grip

The interface between the layers is controlled at the nano level, allowing the TOUGH-Grip layer extremely high levels of adhesion to prevent delamination.

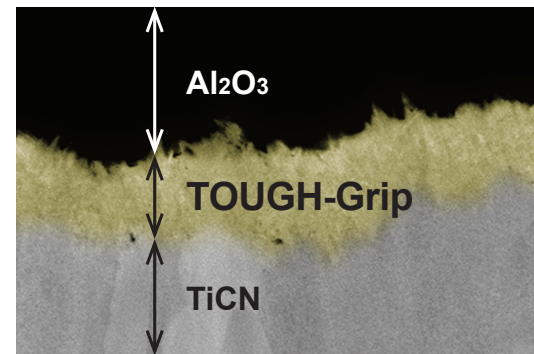

## SUB-Grip

By increasing the degree of adhesion between the carbide substrate and the coating layer, a coating layer has been developed that is resistant to peeling even during strong intermittent machining.

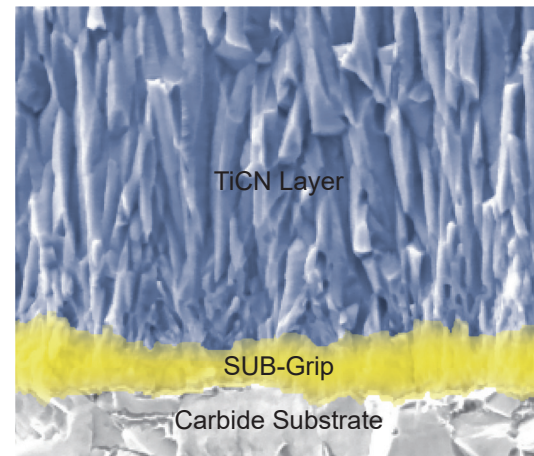

By Image

For high speed cutting of gray cast iron

# MC5105

## Harder and With Outstanding Wear Resistance

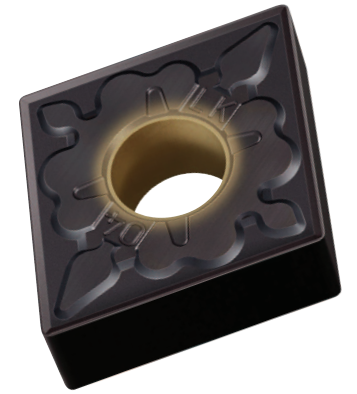

### A thick top coating layer

### Intermediate layer suitable for high speed cutting

#### Adhesion Strength Evaluation\*

\*Adhesion strength measurement is obtained from a scratch test that records the force needed to peel the coating layers.

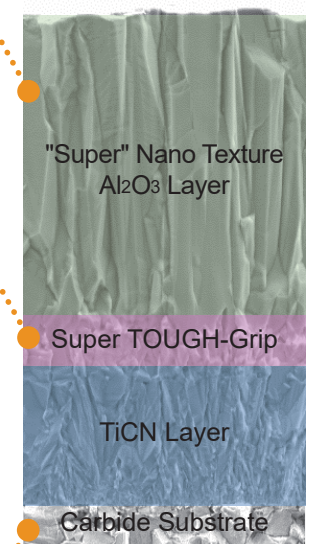
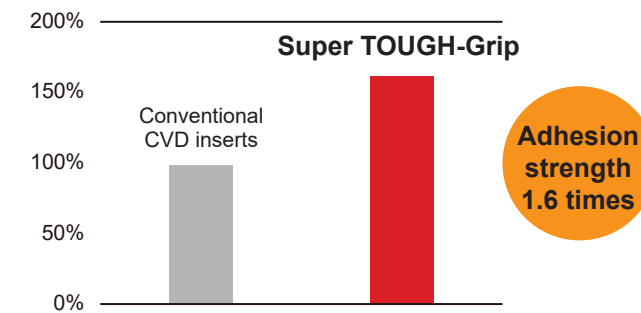

### The substrate adopts a high hardness carbide material

## Comparison of wear resistance of No 45 B at cutting speeds of 3280 SFM

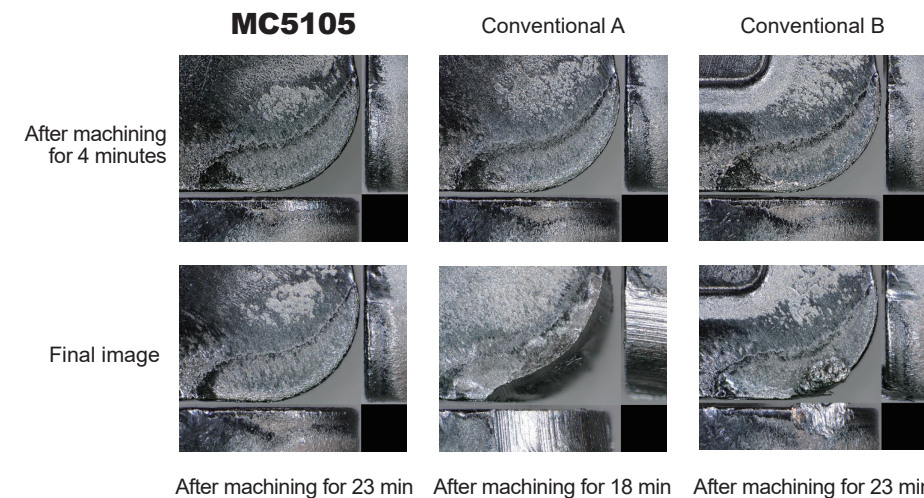

<Cutting Conditions>  
 Material : ASTM No 45 B  
 Inserts : CNMA433  
 Cutting Speed : vc = 3280 SFM  
 Feed per Rev. : f = .012 IPR  
 Depth of Cut : ap = .079 inch  
 Cutting Mode : Dry Cutting

First recommended grade for ductile cast iron

# MC5115

Excellent Durability and Resistance to Impacts

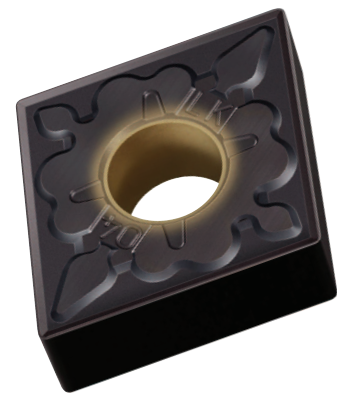

Al<sub>2</sub>O<sub>3</sub> layer with excellent wear resistance

Intermediate layer with microstructure suitable for ductile cast iron

Thick TiCN layer suitable for coping with the hardness of ductile cast iron

New adhesion layer with an enhanced resistance to peeling

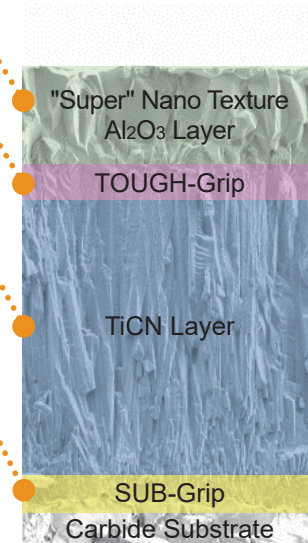

## Comparison of wear resistance during continuous cutting of 100-70-03

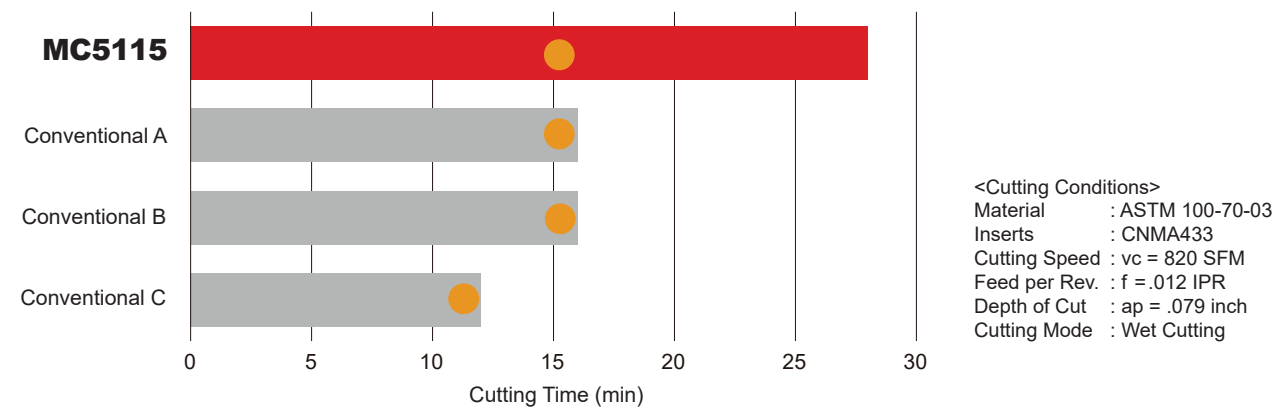

After machining for 16 minutes



MC5115

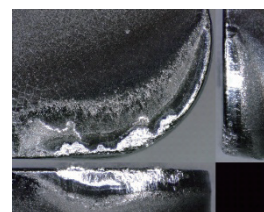

Conventional A

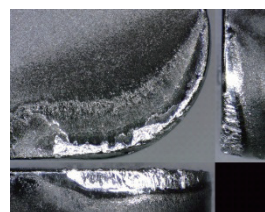

Conventional B

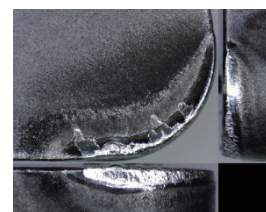

Conventional C

After machining for 12 minutes

For heavy interrupted cutting of ductile cast iron

# MC5125

Excellent Stability and Fracture Resistance

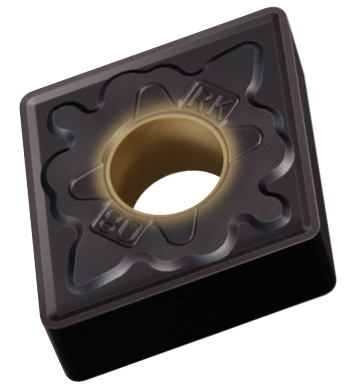

Al<sub>2</sub>O<sub>3</sub> layer with excellent wear resistance

Intermediate layer with microstructure suitable for ductile cast iron

TiCN layer for hardness for heavy interrupted cutting

New adhesion layer with an enhanced resistance to peeling

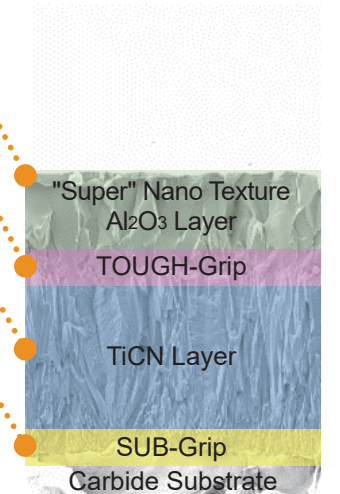

## Comparison of fracture resistance after 10 passes of interrupted cutting of 100-70-03

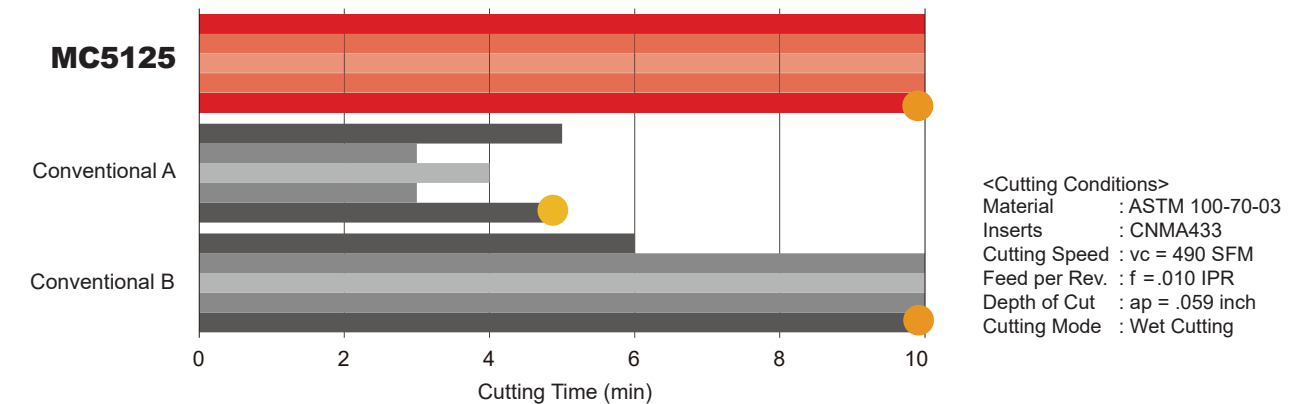

After machining for 10 passes



MC5125

After machining for 5 passes



Conventional A

After machining for 10 passes



Conventional B

# Way to Select MC5100 Series

## Gray Cast Iron

MC5105 is the first recommendation for high speed machining of gray cast iron.  
 Select a suitable chipbreaker to optimise tool life and reduce wear.  
 MC5115 is also capable of reliable machining at speeds of 330-985 SFM and for unstable cutting conditions.

### High Speed Cutting 655–3280 SFM

# MC5105

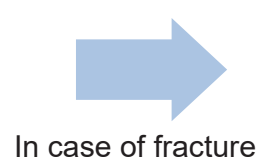

Change to a chipbreaker with a stronger cutting edge geometry

### Cutting Speed 330–985 SFM

# MC5115



Change to a chipbreaker with a sharper cutting edge geometry

Refer to page 10 and 11 for the chipbreaker selection.

	Medium Cutting	Rough Cutting	Heavy Cutting
● (Stable Cutting)	MK MC5105	RK MC5105	Flat Top MC5105
● (General Cutting)	MK MC5105	RK MC5105	Flat Top MC5105
⊕ (Unstable Cutting)	MK MC5105 MC5115	RK MC5105 MC5115	Flat Top MC5105 MC5115

Cutting Conditions : ● : Stable Cutting ● : General Cutting ⊕ : Unstable Cutting

## Ductile Cast Iron

MC5115 is the first recommendation for ductile cast iron, including high strength ductile cast iron.  
 In order to prevent breakage and wear, select a suitable chipbreaker.  
 MC5125 is also effective for heavy, interrupted and unstable cutting conditions.

### First Recommendation

# MC5115

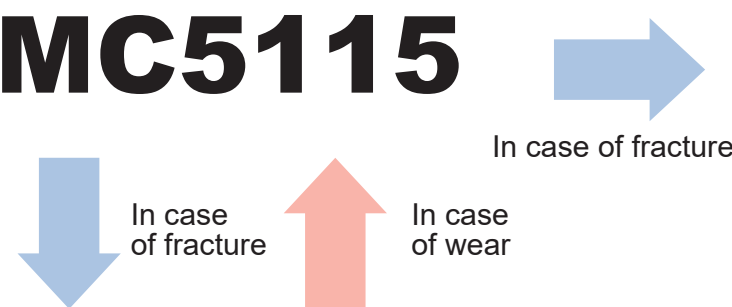

Change to a chipbreaker with a stronger cutting edge geometry

### Heavy, Interrupted Cutting

# MC5125

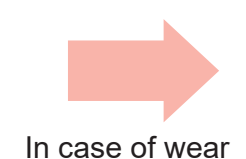

Change to a chipbreaker with a sharper cutting edge geometry

Refer to page 10 and 11 for the chipbreaker selection.

	Light Cutting	Medium Cutting	Rough Cutting	Heavy Cutting
● (Stable Cutting)	LK MC5115	MK MC5115	RK MC5115	Flat Top MC5115
● (General Cutting)	LK MC5115	MK MC5115	RK MC5115	Flat Top MC5115
⊕ (Unstable Cutting)	LK MC5125	MK MC5125	RK MC5125	Flat Top MC5125

Cutting Conditions : ● : Stable Cutting ● : General Cutting ⊕ : Unstable Cutting

# Chipbreaker system for cast iron turning

The entire range of new chipbreaker has been designed by taking advantage of the properties of the new grades. Each chipbreaker has the optimum suitability for each respective application.







## Negative Inserts

### LK/MK/RK/Flat Top, GK/MA

Select a chipbreaker according to the machining conditions.



## Asist Chipbreaker

Cutting Area	Chipbreaker	Features
Light Cutting	SH 	Can be used low depth of cut and high feed rates. The curved edge allows smooth chip discharge.
	SW 	In comparison to conventional chipbreakers, the surface finish is maintained even if the feed per revolution is doubled. A wide chip pocket prevents chip jamming.
Medium Cutting	MP 	Suitable for medium to light cutting. Chipbreaker geometry appropriate for copying and back turning. Cutting edge geometry for an optimum balance of sharpness and fracture resistance.
	MW 	The wiper allows up to double times higher feed. A wide chip pocket prevents chip jamming.
	MH 	Flat land offers high edge strength. Good chip control with suitable chip pocket.
Rough Cutting	GH 	For interrupted cutting and removing scale. A combination of wide land and a large chip pocket allows high feed rates.

## Application map for cast iron

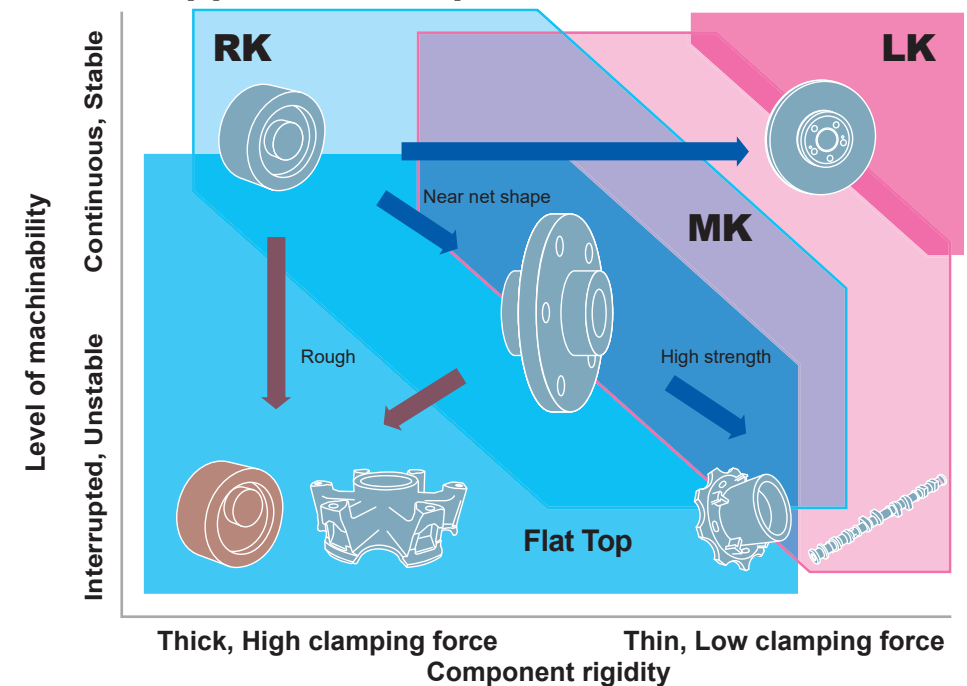

# MC5100 Series

## Negative Inserts (With hole)

M Class

CNMG  
CNMA

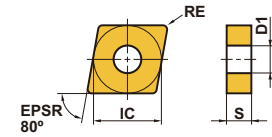

Light Cutting	Light Cutting	Light Cutting	Medium Cutting	Medium Cutting	Medium Cutting
LK	SH	SW (Wiper)	MP	MK	GK
Medium Cutting	Medium Cutting	Medium Cutting	Rough Cutting	Rough Cutting	Strong Cutting Edge
MA	MW (Wiper)	MH	RK	GH	Flat Top

(inch)

Order Number	Cutting Area	Cutting Area			IC	S	RE	D1
		MC5105	MC5115	MC5125				
CNMG431LK	L	●	●	●	.500	.187	.016	.203
CNMG432LK	L	●	●	●	.500	.187	.031	.203
CNMG433LK	L	★	●	★	.500	.187	.047	.203
NEW CNMG431SH	L	●	●	●	.500	.187	.016	.203
NEW CNMG432SH	L	●	●	●	.500	.187	.031	.203
NEW CNMG431SW	L	★	●	★	.500	.187	.016	.203
NEW CNMG432SW	L	●	●	●	.500	.187	.031	.203
NEW CNMG431MP	M	●	●	●	.500	.187	.016	.203
NEW CNMG432MP	M	●	●	●	.500	.187	.031	.203
NEW CNMG433MP	M	★	●	★	.500	.187	.047	.203
NEW CNMG434MP	M	★	●	★	.500	.187	.063	.203
NEW CNMG542MP	M	●	●	●	.625	.250	.031	.250
NEW CNMG543MP	M	●	●	●	.625	.250	.047	.250
NEW CNMG544MP	M	★	●	★	.625	.250	.063	.250
CNMG431MK	M	●	●	●	.500	.187	.016	.203
CNMG432MK	M	●	●	●	.500	.187	.031	.203
CNMG433MK	M	●	●	●	.500	.187	.047	.203
CNMG434MK	M	●	●	●	.500	.187	.063	.203
CNMG542MK	M	●	●	★	.625	.250	.031	.250
CNMG543MK	M	★	●	●	.625	.250	.047	.250
CNMG544MK	M	●	●	★	.625	.250	.063	.250
CNMG643MK	M	●	●	●	.750	.250	.047	.312
CNMG644MK	M	★	★	★	.750	.250	.063	.312
CNMG431GK	M	★	●	★	.500	.187	.016	.203
CNMG432GK	M	●	●	●	.500	.187	.031	.203
CNMG433GK	M	★	●	★	.500	.187	.047	.203
CNMG434GK	M	★	★	★	.500	.187	.063	.203
CNMG543GK	M	●	●	●	.625	.250	.047	.250
CNMG544GK	M	★	★	★	.625	.250	.063	.250
NEW CNMG643GK	M	★	●	●	.750	.250	.047	.312
NEW CNMG644GK	M	★	★	★	.750	.250	.063	.312
CNMG431MA	M	●	●	●	.500	.187	.016	.203
CNMG432MA	M	●	●	●	.500	.187	.031	.203
CNMG433MA	M	●	●	●	.500	.187	.047	.203
CNMG434MA	M	★	★	★	.500	.187	.063	.203
CNMG542MA	M	★	●	●	.625	.250	.031	.250
CNMG543MA	M	★	●	●	.625	.250	.047	.250
CNMG544MA	M	★	★	★	.625	.250	.063	.250
NEW CNMG643MA	M	★	●	●	.750	.250	.047	.312
NEW CNMG644MA	M	★	★	★	.750	.250	.063	.312

● : USA Stock ★ : Stocked in Japan (10 inserts in one case)

● = NEW

## Negative Inserts (With hole)

M Class

DNMG  
DNMA

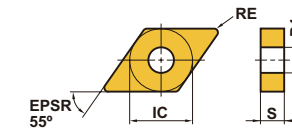

Light Cutting	Light Cutting	Medium Cutting	Medium Cutting	Medium Cutting	Medium Cutting
LK	SH	MP	MK	GK	MA
Medium Cutting	Medium Cutting	Rough Cutting	Rough Cutting	Strong Cutting Edge	
MH	MW (Wiper)	RK	GH	Flat Top	

(inch)

Order Number	Cutting Area	Cutting Area			IC	S	RE	D1
		MC5105	MC5115	MC5125				
DNMG332LK	L	●	●	★	.375	.187	.031	.150
DNMG431LK	L	★	●	★	.500	.187	.016	.203
DNMG432LK	L	●	●	●	.500	.187	.031	.203
DNMG433LK	L	★	●	★	.500	.187	.047	.203
DNMG441LK	L	★	★	★	.500	.250	.016	.203
DNMG442LK	L	★	★	★	.500	.250	.031	.203
DNMG443LK	L	★	★	★	.500	.250	.047	.203
NEW DNMG431SH	L	★	●	★	.500	.187	.016	.203
NEW DNMG432SH	L	★	●	★	.500	.187	.031	.203
NEW DNMG433SH	L	★	●	★	.500	.187	.047	.203
NEW DNMG442SH	L	★	★	★	.500	.250	.031	.203
NEW DNMG443SH	L	★	★	★	.500	.250	.047	.203
NEW DNMG431MP	M	★	●	★	.500	.187	.016	.203
NEW DNMG432MP	M	●	●	●	.500	.187	.031	.203
NEW DNMG433MP	M	★	●	★	.500	.187	.047	.203
NEW DNMG434MP	M	★	●	★	.500	.187	.063	.203
NEW DNMG441MP	M	★	★	★	.500	.250	.016	.203
NEW DNMG442MP	M	★	★	★	.500	.250	.031	.203
NEW DNMG443MP	M	★	★	★	.500	.250	.047	.203
NEW DNMG444MP	M	★	★	★	.500	.250	.063	.203
DNMG332MK	M	★	●	●	.375	.187	.031	.150
DNMG431MK	M	●	●	●	.500	.187	.016	.203
DNMG432MK	M	●	●	●	.500	.187	.031	.203
DNMG433MK	M	★	●	●	.500	.187	.047	.203
DNMG441MK	M	★	★	★	.500	.250	.016	.203
DNMG442MK	M	★	★	★	.500	.250	.031	.203
DNMG443MK	M	★	★	★	.500	.250	.047	.203
NEW DNMG332GK	M	★	●	★	.375	.187	.031	.150
DNMG431GK	M	★	★	★	.500	.187	.016	.203
DNMG432GK	M	●	●	●	.500	.187	.031	.203
DNMG433GK	M	★	★	★	.500	.187	.047	.203
DNMG441GK	M	★	★	★	.500	.250	.016	.203
DNMG442GK	M	★	★	★	.500	.250	.031	.203
DNMG443GK	M	★	★	★	.500	.250	.047	.203
DNMG431MA	M	★	●	★	.500	.187	.016	.203
DNMG432MA	M	●	●	●	.500	.187	.031	.203
DNMG433MA	M	●	●	★	.500	.187	.047	.203
DNMG441MA	M	★	★	★	.500	.250	.016	.203
DNMG442MA	M	★	★	★	.500	.250	.031	.203
DNMG443MA	M	★	★	★	.500	.250	.047	.203

● = NEW

Order Number	Cutting Area	Cutting Area			IC	S	RE	D1
		MC5105	MC5115	MC5125				
NEW DNMG432MH	M	●	●	●	.500	.187	.031	.203
NEW DNMG433MH	M	●	●	●	.500	.187	.047	.203
NEW DNMG441MH	M	★	●	★	.500	.250	.016	.203
NEW DNMG442MH	M	★	●	★	.500	.250	.031	.203
NEW DNMG443MH	M	★	●	★	.500	.250	.047	.203
NEW DNMX432MW	M	●	●	★	.500	.187	.031	.203
NEW DNMX433MW	M	★	●	★	.500	.187	.047	.203
NEW DNMX442MW	M	★	★	★	.500	.250	.031	.203
NEW DNMX443MW	M	★	★	★	.500	.250	.047	.203
DNMG432RK	R	★	●	●	.500	.187	.031	.203
DNMG433RK	R	★	●	★	.500	.187	.047	.203
DNMG442RK	R	★	★	★	.500	.250	.031	.203
DNMG443RK	R	★	★	★	.500	.250	.047	.203
NEW DNMG432GH	R	●	●	●	.500	.187	.031	.203
NEW DNMG433GH	R	★	●	★	.500	.187	.047	.203
NEW DNMG442GH	R	★	★	★	.500	.250	.031	.203
NEW DNMG443GH	R	★	★	★	.500	.250	.047	.203
DNMA431	-	★	●	★	.500	.187	.016	.203
DNMA432	-	●	●	●	.500	.187	.031	.203
DNMA433	-	●	●	★	.500	.187	.047	.203
DNMA441	-	★	●	★	.500	.250	.016	.203
DNMA442	-	★	●	★	.500	.250	.031	.203
DNMA443	-	★	●	★	.500	.250	.047	.203

# MC5100 Series

## Negative Inserts (With hole)

M Class

SNMG  
SNMA

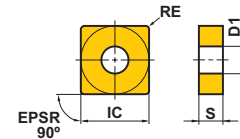

Light Cutting	Light Cutting	Medium Cutting	Medium Cutting	Medium Cutting	Medium Cutting
LK	SH	MP	MK	GK	MA
Medium Cutting	Rough Cutting	Rough Cutting	Strong Cutting Edge		
Medium Cutting			Flat Top		
MH	RK	GH			

(inch)

Order Number	Cutting Area	MC5100			IC	S	RE	D1
		MC5105	MC5115	MC5125				
SNMG432LK	L	★	★	★	.500	.187	.031	.203
SNMG433LK	L	★	●	★	.500	.187	.047	.203
NEW SNMG431SH	L		★		.500	.187	.016	.203
NEW SNMG432SH	L		★		.500	.187	.031	.203
NEW SNMG433SH	L		★		.500	.187	.047	.203
NEW SNMG431MP	M		★		.500	.187	.016	.203
NEW SNMG432MP	M		★		.500	.187	.031	.203
NEW SNMG433MP	M		★		.500	.187	.047	.203
SNMG432MK	M	★	●	★	.500	.187	.031	.203
SNMG433MK	M	●	●	★	.500	.187	.047	.203
SNMG434MK	M	★	★	★	.500	.187	.063	.203
SNMG543MK	M	★	●	★	.625	.250	.047	.250
SNMG544MK	M	★	●	★	.625	.250	.063	.250
SNMG643MK	M	★	●	★	.750	.250	.047	.312
SNMG644MK	M	★	★	★	.750	.250	.063	.312
SNMG431GK	M	★	●	★	.500	.187	.016	.203
SNMG432GK	M	★	●	★	.500	.187	.031	.203
SNMG433GK	M	★	●	★	.500	.187	.047	.203
SNMG434GK	M	★	★	●	.500	.187	.063	.203
SNMG543GK	M	●	★	●	.625	.250	.047	.250
NEW SNMG643GK	M	★	★	★	.750	.250	.047	.312
NEW SNMG644GK	M		●	●	.750	.250	.063	.312
SNMG431MA	M	★	★	★	.500	.187	.016	.203
SNMG432MA	M	★	●	●	.500	.187	.031	.203
SNMG433MA	M	●	●	★	.500	.187	.047	.203
SNMG434MA	M	★	★	★	.500	.187	.063	.203
SNMG543MA	M		★	★	.625	.250	.047	.250
NEW SNMG643MA	M		●	★	.750	.250	.047	.312
NEW SNMG432MH	M		●		.500	.187	.031	.203
NEW SNMG433MH	M		●		.500	.187	.047	.203
NEW SNMG643MH	M		★		.750	.250	.047	.312

● = NEW

● : USA Stock ★ : Stocked in Japan  
(10 inserts in one case)

## Negative Inserts (With hole)

M Class

TNMG  
TNMA  
TNMX

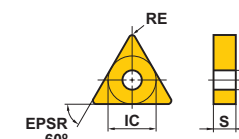

Light Cutting	Light Cutting	Medium Cutting	Medium Cutting	Medium Cutting	Medium Cutting
LK	SH	MP	MK	GK	MA
Medium Cutting	Medium Cutting	Rough Cutting	Rough Cutting	Strong Cutting Edge	
Medium Cutting				Flat Top	
MH	MW	RK	GH		

(Wiper)

(inch)

Order Number	Cutting Area	MC5100			IC	S	RE	D1
		MC5105	MC5115	MC5125				
TNMG331LK	L	●	★	★	.375	.187	.016	.150
TNMG332LK	L	●	●	★	.375	.187	.031	.150
TNMG333LK	L	★	★	★	.375	.187	.047	.150
NEW TNMG331SH	L		★		.375	.187	.016	.150
NEW TNMG332SH	L		●		.375	.187	.031	.150
NEW TNMG331MP	M		★		.375	.187	.016	.150
NEW TNMG332MP	M		★		.375	.187	.031	.150
NEW TNMG333MP	M		★		.375	.187	.047	.150
NEW TNMG432MP	M		★		.500	.187	.031	.203
NEW TNMG433MP	M		★		.500	.187	.047	.203
TNMG331MK	M	★	●	★	.375	.187	.016	.150
TNMG332MK	M	★	●	★	.375	.187	.031	.150
TNMG333MK	M	★	★	★	.375	.187	.047	.150
TNMG432MK	M	●	★	★	.500	.187	.031	.203
TNMG433MK	M	★	★	★	.500	.187	.047	.203
TNMG434MK	M	★	★	★	.500	.187	.063	.203
TNMG331GK	M	★	★	★	.375	.187	.016	.150
TNMG332GK	M	★	●	★	.375	.187	.031	.150
TNMG333GK	M	★	★	★	.375	.187	.047	.150
TNMG334GK	M	★	★	★	.375	.187	.063	.150
TNMG432GK	M	★	●	★	.500	.187	.031	.203
TNMG433GK	M	★	★	★	.500	.187	.047	.203
TNMG331MA	M	★	★	★	.375	.187	.016	.150
TNMG332MA	M	●	●	●	.375	.187	.031	.150
TNMG333MA	M	★	●	★	.375	.187	.047	.150
TNMG334MA	M	★	★	★	.375	.187	.063	.150
TNMG432MA	M	●	●	★	.500	.187	.031	.203
TNMG433MA	M	★	●	★	.500	.187	.047	.203
TNMG434MA	M		★	★	.500	.187	.063	.203
NEW TNMG331MH	M		★		.375	.187	.016	.150
NEW TNMG332MH	M		★		.375	.187	.031	.150
NEW TNMG333MH	M		★		.375	.187	.047	.150
NEW TNMG432MH	M		●		.500	.187	.031	.203
NEW TNMG433MH	M		●		.500	.187	.047	.203
NEW TNMX332MW	M	★	★	★	.375	.187	.031	.150
NEW TNMX333MW	M	★	★	★	.375	.187	.047	.150

● = NEW

# MC5100 Series

## Negative Inserts (With hole)

M Class

VNMG  
VNMA

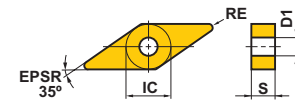

Light Cutting	Medium Cutting	Medium Cutting	Medium Cutting	Medium Cutting	Medium Cutting
LK	MP	MK	GK	MA	MH
Strong Cutting Edge					
Flat Top					

(inch)

Order Number	Cutting Area	Cutting Area			IC	S	RE	D1
		MC5105	MC5115	MC5125				
VNMG331LK	L	●	●	★	.375	.187	.016	.150
VNMG332LK	L	●	●	★	.375	.187	.031	.150
NEW VNMG331MP	M		★		.375	.187	.016	.150
NEW VNMG332MP	M		●		.375	.187	.031	.150
NEW VNMG333MP	M		●		.375	.187	.047	.150
VNMG331MK	M	●	●	★	.375	.187	.016	.150
VNMG332MK	M	★	●	●	.375	.187	.031	.150
VNMG333MK	M	★	●	★	.375	.187	.047	.150
VNMG331GK	M	●	★	★	.375	.187	.016	.150
VNMG332GK	M	●	●	●	.375	.187	.031	.150
VNMG333GK	M	★	●	★	.375	.187	.047	.150
VNMG331MA	M	●	●	★	.375	.187	.016	.150
VNMG332MA	M	●	●	●	.375	.187	.031	.150
NEW VNMG331MH	M		●		.375	.187	.016	.150
NEW VNMG332MH	M		●		.375	.187	.031	.150
VNMA331	-	★	●	★	.375	.187	.016	.150
VNMA332	-	★	●	★	.375	.187	.031	.150
VNMA333	-	★	★	★	.375	.187	.047	.150

● = NEW

● : USA Stock ★ : Stocked in Japan  
(10 inserts in one case)

## Negative Inserts (With hole)

M Class

WNMG  
WNMA

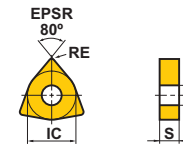

Light Cutting	Light Cutting	Light Cutting	Medium Cutting	Medium Cutting	Medium Cutting
LK	SH	SW	MP	MK	GK
(Wiper)					
Medium Cutting	Medium Cutting	Medium Cutting	Rough Cutting	Rough Cutting	Strong Cutting Edge
MA	MH	MW	RK	GH	Flat Top
(Wiper)					

(inch)

Order Number	Cutting Area	Cutting Area			IC	S	RE	D1
		MC5105	MC5115	MC5125				
WNMG431LK	L	●	●	●	.500	.187	.016	.203
WNMG432LK	L	●	●	★	.500	.187	.031	.203
WNMG433LK	L	★	★	★	.500	.187	.047	.203
NEW WNMG431SH	L		★		.500	.187	.016	.203
NEW WNMG432SH	L		★		.500	.187	.031	.203
NEW WNMG433SH	L		★		.500	.187	.047	.203
NEW WNMG431SW	L	★	★	★	.500	.187	.016	.203
NEW WNMG432SW	L	●	●	★	.500	.187	.031	.203
NEW WNMG32.51MP	M		★		.375	.156	.016	.150
NEW WNMG32.52MP	M		★		.375	.156	.031	.150
NEW WNMG32.53MP	M		★		.375	.156	.047	.150
NEW WNMG331MP	M		★		.375	.187	.016	.150
NEW WNMG332MP	M		●		.375	.187	.031	.150
NEW WNMG333MP	M		★		.375	.187	.047	.150
NEW WNMG431MP	M		★		.500	.187	.016	.203
NEW WNMG432MP	M		★		.500	.187	.031	.203
NEW WNMG433MP	M		★		.500	.187	.047	.203
NEW WNMG434MP	M		★		.500	.187	.063	.203
WNMG431MK	M	●	●	★	.500	.187	.016	.203
WNMG432MK	M	●	●	●	.500	.187	.031	.203
WNMG433MK	M	★	●	★	.500	.187	.047	.203
WNMG434MK	M	★	●	★	.500	.187	.063	.203
WNMG331GK	M	★	●	★	.375	.187	.016	.150
WNMG332GK	M	●	●	★	.375	.187	.031	.150
WNMG431GK	M	★	●	★	.500	.187	.016	.203
WNMG432GK	M	●	●	★	.500	.187	.031	.203
WNMG433GK	M	★	●	★	.500	.187	.047	.203
WNMG434GK	M	★	★	★	.500	.187	.063	.203
WNMG332MA	M	★	●	★	.375	.187	.031	.150
WNMG333MA	M	★	★	★	.375	.187	.047	.150
WNMG431MA	M	★	●	★	.500	.187	.016	.203
WNMG432MA	M	●	●	●	.500	.187	.031	.203
WNMG433MA	M	●	●	●	.500	.187	.047	.203
WNMG434MA	M	★	★	●	.500	.187	.063	.203
NEW WNMG432MH	M		●		.500	.187	.031	.203
NEW WNMG433MH	M		●		.500	.187	.047	.203
NEW WNMG332MW	M	●	●	★	.375	.187	.031	.150
NEW WNMG333MW	M	★	★	★	.375	.187	.047	.150
NEW WNMG432MW	M	●	●	●	.500	.187	.031	.203
NEW WNMG433MW	M	★	●	●	.500	.187	.047	.203

● = NEW

Order Number	Cutting Area	Cutting Area			IC	S	RE	D1
		MC5105	MC5115	MC5125				
WNMG432RK	R	●	●	●	.500	.187	.031	.203
WNMG433RK	R	●	●	★	.500	.187	.047	.203
WNMG434RK	R	★	●	★	.500	.187	.063	.203
NEW WNMG432GH	R	●	●	●	.500	.187	.031	.203
NEW WNMG433GH	R	●	●	★	.500	.187	.047	.203
WNMA332	-	★	★	★	.375	.187	.031	.150
WNMA333	-	●	★	★	.375	.187	.047	.150
WNMA431	-	★	★	★	.500	.187	.016	.203
WNMA432	-	●	●	●	.500	.187	.031	.203
WNMA433	-	●	●	●	.500	.187	.047	.203
WNMA434	-	★	●	★	.500	.187	.063	.203

# MC5100 Series

## Negative Inserts (Without hole)

M Class

CNMN

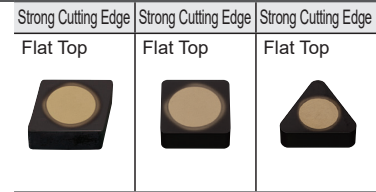
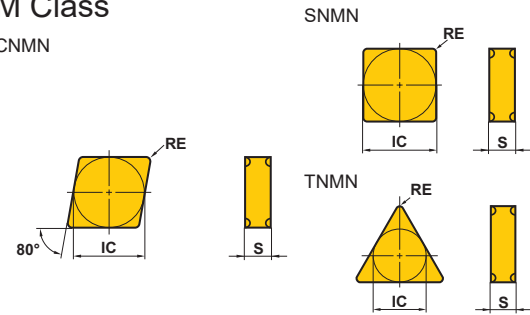

(inch)

Order Number	Cutting Area	MC5105			IC	S	RE	D1
		MC5105	MC5115	MC5125				
CNMN432	-	★	●	★	.500	.187	.031	-
CNMN433	-	★	●	★	.500	.187	.047	-
CNMN434	-	★	●	★	.500	.187	.063	-
SNMN432	-	●	●	★	.500	.187	.031	-
SNMN433	-	★	★	★	.500	.187	.047	-
SNMN434	-	★	★	★	.500	.187	.063	-
SNMN435	-	★	★	★	.500	.187	.079	-

Order Number	Cutting Area	MC5105			IC	S	RE	D1
		MC5105	MC5115	MC5125				
TNMN332	-	★	★	★	.375	.187	.031	-
TNMN333	-	★	★	★	.375	.187	.047	-
TNMN334	-	★	★	★	.375	.187	.063	-
TNMN335	-	★	★	★	.375	.187	.079	-

● : USA Stock ★ : Stocked in Japan  
(10 inserts in one case)

## 5° Positive inserts (With hole)

NEW

M Class

VBMT  
VBMW

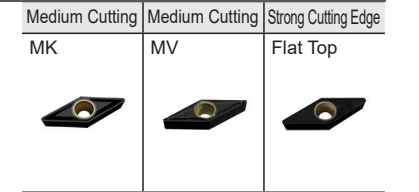
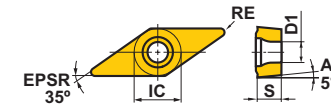

(inch)

Order Number	Cutting Area	MC5105			IC	S	RE	D1
		MC5105	MC5115	MC5125				
VBMT331MK	M	★	●	★	.375	.187	.016	.173
VBMT332MK	M	●	●	★	.375	.187	.031	.173
VBMT221MV	M		★		.250	.125	.016	.114
VBMT222MV	M		●		.250	.125	.031	.114
VBMT331MV	M		★		.375	.187	.016	.173
VBMT332MV	M		●		.375	.187	.031	.173
VBMW332	-	★	★	★	.375	.187	.031	.173

● = NEW

# MC5100 Series

## 7° Positive inserts (With hole)

M Class

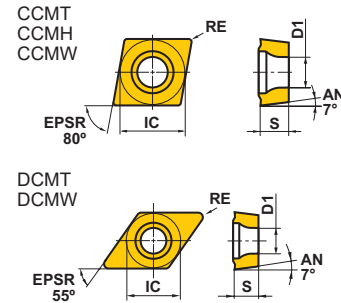

Light Cutting SW	Medium Cutting MK	Medium Cutting MV	Medium Cutting MW	Strong Cutting Edge Flat Top
 (Wiper)			 (Wiper)	
Medium Cutting MK	Medium Cutting MV	Strong Cutting Edge Flat Top		

(inch)

Order Number	Cutting Area	MC5105	MC5115	MC5125	IC	S	RE	D1
NEW CCMT21.51SW	L	★			.250	.094	.016	.110
NEW CCMT32.50.5SW	L	★			.375	.156	.008	.173
NEW CCMT32.51SW	L	●			.375	.156	.016	.173
NEW CCMT21.50.5MK	M	●	●	●	.250	.094	.008	.110
CCMT21.51MK	M	●	●	●	.250	.094	.016	.110
CCMT21.52MK	M	●	●	●	.250	.094	.031	.110
NEW CCMT32.50.5MK	M	●	●	●	.375	.156	.008	.173
CCMT32.51MK	M	●	●	●	.375	.156	.016	.173
CCMT32.52MK	M	●	●	●	.375	.156	.031	.173
CCMT431MK	M	●	★	★	.500	.187	.016	.217
CCMT432MK	M	●	●	●	.500	.187	.031	.217
CCMT433MK	M	●	●	★	.500	.187	.047	.217
NEW CCMH21.51MV	M		★		.250	.094	.016	.110
NEW CCMT431MW	M		★		.500	.187	.016	.217
NEW CCMT432MW	M		★		.500	.187	.031	.217
NEW CCMW21.51	-	★	●	●	.250	.094	.016	.110
NEW CCMW21.52	-	●	●	★	.250	.094	.031	.110
NEW CCMW32.51	-	●	●	●	.375	.156	.016	.173
NEW CCMW32.52	-	●	●	●	.375	.156	.031	.173
NEW CCMW32.53	-	★	★	★	.375	.156	.047	.173
NEW CCMW431	-	★	★	★	.500	.187	.016	.217
NEW CCMW432	-	★	●	★	.500	.187	.031	.217
NEW CCMW433	-	★	★	★	.500	.187	.047	.217

Order Number	Cutting Area	MC5105	MC5115	MC5125	IC	S	RE	D1
NEW DCMT21.50.5MK	M	●	●	●	.250	.094	.008	.110
DCMT21.51MK	M	★	●	●	.250	.094	.016	.110
DCMT21.52MK	M	★	●	★	.250	.094	.031	.110
NEW DCMT32.50.5MK	M	●	●	●	.375	.156	.008	.173
DCMT32.51MK	M	★	●	●	.375	.156	.016	.173
DCMT32.52MK	M	●	●	●	.375	.156	.031	.173
DCMT431MK	M	★	●	★	.500	.187	.016	.217
DCMT432MK	M	★	●	★	.500	.187	.031	.217
NEW DCMT21.51MV	M		★		.250	.094	.016	.110
NEW DCMT21.52MV	M		★		.250	.094	.031	.110
NEW DCMT32.51MV	M		●		.375	.156	.016	.173
NEW DCMT32.52MV	M		●		.375	.156	.031	.173
DCMW21.51	-	★	★	★	.250	.094	.016	.110
NEW DCMW32.51	-	●	★	★	.375	.156	.016	.173
NEW DCMW32.52	-	★	★	★	.375	.156	.031	.173



● = NEW

## 7° Positive Inserts (With Hole)

NEW

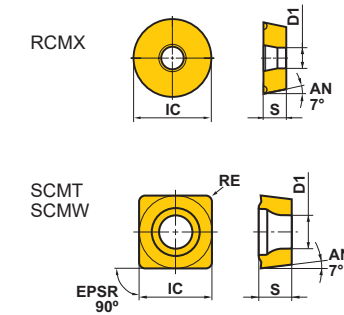
M Class



Medium Cutting Standard	
	
Medium Cutting MK	Strong Cutting Edge Flat Top
	

(inch)

Order Number	Cutting Area	MC5105	MC5115	MC5125	IC	S	RE	D1
RCMX1204M0	M	★			.472	.187	-	.165

Order Number	Cutting Area	MC5105	MC5115	MC5125	IC	S	RE	D1
SCMT32.51MK	M	★	●	★	.375	.156	.016	.173
SCMT32.52MK	M	★	●	★	.375	.156	.031	.173
SCMT431MK	M	★	★	★	.500	.187	.016	.217
SCMT432MK	M	★	★	★	.500	.187	.031	.217
SCMW32.51	-	★	★	★	.375	.156	.016	.173
SCMW32.52	-	★	★	★	.375	.156	.031	.173
SCMW432	-	●	●	★	.500	.187	.031	.217

● = NEW

● : USA Stock ★ : Stocked in Japan  
(10 inserts in one case)

# MC5100 Series

## 7° Positive Inserts (With Hole) NEW M Class

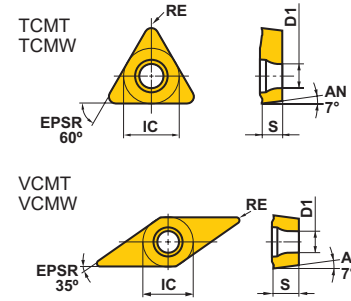

Light Cutting	Medium Cutting	Strong Cutting Edge
LK	MK	Flat Top
Medium Cutting	Medium Cutting	Strong Cutting Edge
MK	MV	Flat Top

(inch)

Order Number	Cutting Area	Cutting Area			IC	S	RE	D1
		MC5105	MC5115	MC5125				
TCMT21.50.5LK	L	●	●	●	.250	.094	.008	.110
TCMT21.51LK	L	●	●	●	.250	.094	.016	.110
TCMT21.52LK	L	●	●	●	.250	.094	.031	.110
TCMT21.51MK	M	●	●	★	.250	.094	.016	.110
TCMT21.52MK	M	★	●	★	.250	.094	.031	.110
TCMT21.51MV	M	★	●	★	.375	.156	.016	.173
TCMT21.52MV	M	★	●	★	.375	.156	.031	.173
TCMT32.51MK	M	★	●	★	.375	.156	.031	.173
TCMT32.52MK	M	★	●	★	.375	.156	.047	.173
TCMT32.53MK	M	★	★	★	.375	.156	.047	.173
TCMW21.51	-	●	★	★	.250	.094	.016	.110
TCMW32.51	-	★	●	★	.375	.156	.016	.173
TCMW32.52	-	★	●	★	.375	.156	.031	.173
TCMW32.53	-	★	★	★	.375	.156	.047	.173

Order Number	Cutting Area	Cutting Area			IC	S	RE	D1
		MC5105	MC5115	MC5125				
VCMT331MK	M	★	★	★	.375	.187	.016	.173
VCMT332MK	M	★	●	★	.375	.187	.031	.173
VCMT1.51.51MV	M	●	★	★	.187	.094	.016	.094
VCMW331	-	●	★	★	.375	.187	.016	.173
VCMW332	-	★	★	★	.375	.187	.031	.173

● = NEW

## 11° Positive Inserts (With Hole) NEW M Class

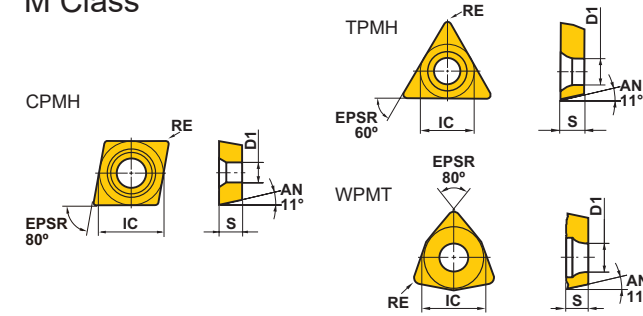

Medium Cutting	Medium Cutting	Light Cutting	Medium Cutting
MK	MV	LK	MV
Medium Cutting			
MV			

(inch)

Order Number	Cutting Area	Cutting Area			IC	S	RE	D1
		MC5105	MC5115	MC5125				
CPMH2.51.51MK	M	●	●	●	.313	.094	.016	.138
CPMH2.51.52MK	M	●	●	●	.313	.094	.031	.138
CPMH321MK	M	●	●	●	.375	.125	.016	.177
CPMH322MK	M	●	●	●	.375	.125	.031	.177
CPMH2.51.51MV	M	★	●	★	.313	.094	.016	.138
CPMH2.51.52MV	M	★	●	★	.313	.094	.031	.138
CPMH321MV	M	★	●	★	.375	.125	.016	.177
CPMH322MV	M	★	●	★	.375	.125	.031	.177

Order Number	Cutting Area	Cutting Area			IC	S	RE	D1
		MC5105	MC5115	MC5125				
TPMH220.5LK	L	●	●	●	.250	.125	.008	.134
TPMH221LK	L	●	●	●	.250	.125	.016	.134
TPMH222LK	L	●	●	●	.250	.125	.031	.134
TPMH320.5LK	L	●	●	●	.375	.125	.008	.173
TPMH321LK	L	●	●	●	.375	.125	.016	.173
TPMH322LK	L	●	●	●	.375	.125	.031	.173
TPMH1.51.51MV	M	●	★	★	.187	.094	.016	.094
TPMH1.81.51MV	M	★	★	★	.219	.094	.016	.114
TPMH1.81.52MV	M	★	★	★	.219	.094	.031	.114
TPMH221MV	M	●	★	★	.250	.125	.016	.134
TPMH222MV	M	●	★	★	.250	.125	.031	.134
TPMH321MV	M	★	★	★	.375	.125	.016	.173
TPMH322MV	M	★	★	★	.375	.125	.031	.173
WPMT21.51MV	M	★	★	★	.250	.094	.016	.110
WPMT321MV	M	★	★	★	.375	.125	.016	.173
WPMT322MV	M	★	★	★	.375	.125	.031	.173

● = NEW

● : USA Stock ★ : Stocked in Japan  
(10 inserts in one case)

# MC5100 Series

## 11° Positive Inserts (Without Hole) NEW

M Class

TPMR  
TPMN

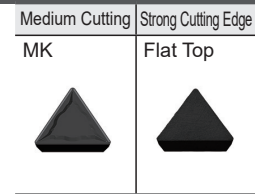
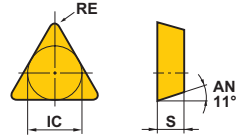

(inch)

Order Number	Cutting Area	Cutting Area			IC	S	RE	D1
		MC5105	MC5115	MC5125				
TPMR221MK	M	●	●	●	.250	.125	.016	-
TPMR222MK	M	●	●	●	.250	.125	.031	-
TPMR321MK	M	●	●	●	.375	.125	.016	-
TPMR322MK	M	●	●	●	.375	.125	.031	-
TPMN221	-	★	★	★	.250	.125	.016	-
TPMN222	-	★	●	★	.250	.125	.031	-
TPMN321	-	★	★	★	.375	.125	.016	-
TPMN322	-	●	★	★	.375	.125	.031	-
TPMN323	-	★	★	★	.375	.125	.047	-

● = NEW

● : USA Stock ★ : Stocked in Japan  
(10 inserts in one case)

## Recommended Cutting Conditions

### Negative Inserts (For External Turning)

Material	Properties	Cutting Conditions	Grade	Cutting Speed vc (SFM)
Gray Cast Iron	Tensile Strength ≤350MPa	●	MC5105	755–2295
		●	MC5105	690–2100
		✚	MC5105	640–1985
		✚	MC5115	620–1150
Ductile Cast Iron	Tensile Strength ≤450MPa	●	MC5115	640–1200
		●	MC5115	590–1080
		✚	MC5125	310–620
	Tensile Strength ≤800MPa	●	MC5115	575–1065
		●	MC5115	525–970
		✚	MC5125	280–560

Cutting Area	Chipbreaker	Feed f (IPR)	Depth of Cut ap
Light Cutting	LK	.006–.020	.020–.098
	SH	.004–.016	.012–.079
	SW	.004–.020	.012–.098
Medium Cutting	MK	.008–.022	.020–.157
	GK	.008–.024	.059–.197
	MP	.006–.020	.012–.157
	MA	.008–.020	.012–.157
	MH	.008–.022	.039–.157
	MW	.008–.024	.035–.157
Rough Cutting	RK	.008–.024	.059–.236
	GH	.010–.024	.059–.236
Heavy Cutting	Flat Top	.008–.024	.098–.236

Cutting Conditions : ● : Stable Cutting ● : General Cutting ✚ : Unstable Cutting

## Recommended Cutting Conditions

### 5°, 7° Positive Inserts (For External Turning)

Material	Properties	Cutting Conditions	Grade	Cutting Speed vc (SFM)
K Gray Cast Iron	Tensile Strength ≤350MPa	●	MC5115	620–1150
		●	MC5115	460–885
		⚡	MC5115	260–490
Ductile Cast Iron	Tensile Strength ≤450MPa	●	MC5115	560–1050
		●	MC5115	425–820
		⚡	MC5125	195–425
	Tensile Strength ≤800MPa	●	MC5115	410–785
		●	MC5115	345–655
		⚡	MC5125	180–375

### 11° Positive Inserts (For External Turning)

Material	Properties	Cutting Conditions	Grade	Cutting Speed vc (SFM)
K Gray Cast Iron	Tensile Strength ≤350MPa	●	MC5115	490–985
		●	MC5115	460–885
		⚡	MC5115	260–490
Ductile Cast Iron	Tensile Strength ≤450MPa	●	MC5115	560–1050
		●	MC5115	425–820
		⚡	MC5125	195–425
	Tensile Strength ≤800MPa	●	MC5115	410–785
		●	MC5115	345–655
		⚡	MC5125	180–375

Cutting Area	Chipbreaker	Feed f (IPR)	Depth of Cut ap
Light Cutting	LK	.002–.010	.008–.039
	SW	.002–.009	.008–.059
Medium Cutting	MK	.003–.012	.012–.079
	MV	.003–.012	.012–.079
	Standard	.003–.012	.012–.079
	MW	.004–.014	.031–.098
Heavy Cutting	Flat Top	.003–.012	.012–.079

Cutting Conditions : ● : Stable Cutting ● : General Cutting ⚡ : Unstable Cutting

## Examples of Usage

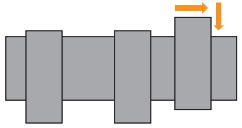
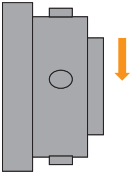
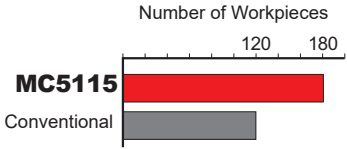
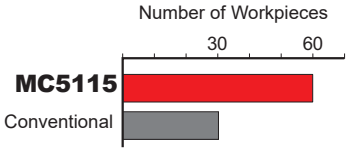
Insert	VNMG332GK	CNMA432	
Workpiece	ASTM 100-70-03 	JIS FCD600 	
Component	Automotive Parts	Automotive Parts	
Application	External Turning and Facing	Facing	
Cutting Conditions	Cutting Speed vc (SFM)	490	720
	Feed per Rev. f (IPR)	.008 - .014	.009 - .010
	Depth of Cut ap (inch)	.039 - .118	.079 - .098
Cutting Mode	Wet Cutting	—	
Results	 The tool life was stable and 1.5 times longer than conventional products.	 Compared to conventional products, the amount of wear has been suppressed and the number of workpieces processed has been doubled.	

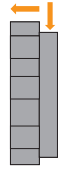
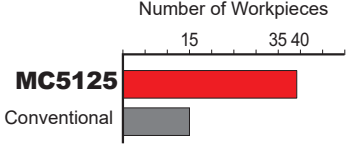
Insert	CNMG433RK	
Workpiece	JIS FCD450 	
Component	Machine Parts	
Application	Rough Cutting of External and Face	
Cutting Conditions	Cutting Speed vc (SFM)	525
	Feed per Rev. f (IPR)	.008
	Depth of Cut ap (inch)	.098 - .138
Cutting Mode	Wet Cutting	
Results	 It was confirmed that the fracture resistance was twice as high as that of conventional products during heavy interrupted machining.	

The application examples are from customers workpieces and can therefore differ from the recommended cutting conditions.



## MITSUBISHI MATERIALS U.S.A. CORPORATION

### California Office (Headquarters)

3535 Hyland Avenue, Suite 200  
Costa Mesa, CA 92626  
Customer Service: 800.523.0800  
Technical Service: 800.486.2341

### Chicago Office (Engineering)

300 N. Martingale Road, Suite 500  
Schaumburg, IL 60173  
Main: 847.252.6300  
Fax: 847.519.1732

### MMC Metal de Mexico, S.A. DE C.V.

Av. La Cañada No.16,  
Parque Industrial Bernardo  
Quintana, El Marques,  
Queretaro C.P. 76246 MEXICO  
Main: +52.442.221.61.36  
Fax: +52.442.221.61.34

### North Carolina-MTEC (Marketing & Technical Center)

105 Corporate Center Drive, Suite A  
Mooresville, NC 28117  
Main: 980.312.3100  
Fax: 704.746.9292

### Toronto Office (Canada Branch)

600 Matheson Blvd. Unit 5 (Office)  
Mississauga, ON L5R 4C1  
Main: 905.814.0240  
Fax: 905.814.0245

### Detroit Office (Moldino CS)

41700 Gardenbrook Road, Suite 120  
Novi, MI 48375  
Main: 248.308.2620  
Fax: 248.308.2627

## FOR YOUR SAFETY

- Don't handle inserts and chips without gloves.
- Please machine within the recommended application range and exchange expired tools with new ones in advance of breakage.
- Please use safety covers and wear safety glasses.
- When using compounded cutting oils, please take fire precautions.
- When attaching inserts or spare parts, please use only the correct wrench or driver.
- When using rotating tools, please make a trial run to check run-out, vibration and abnormal sounds etc.

[www.mmc-carbide.com/us](http://www.mmc-carbide.com/us)

Tools specifications subject to change without notice.

B269A-US-2024.10