



ALLIED MACHINE & ENGINEERING

Holemaking Solutions for Today's Manufacturing



Drilling



Reaming



Burnishing



Threading



Specials



Criterion[®]

▶ *BORING*

Modular Boring Systems

CRITERION[™]

North America

Allied Machine
120 Deeds Drive
Dover, OH 44622
United States

Allied Machine
485 West 3rd Street
Dover, OH 44622
United States

ThreadMills USA™

4185 Crosstowne Ct #B
Evans, GA 30809
United States

Superion™

1285 S Patton St.
Xenia, OH 45385
United States

Europe

Allied Machine Europe
93 Vantage Point
Pensnett Estate
Kingswinford
West Midlands
DY6 7FR, United Kingdom

Wohlhaupter® GmbH

Maybachstrasse 4
Postfach 1264
72636 Frickenhausen
Germany

Asia

Wohlhaupter® India
B-23, 2nd Floor
B Block Community Centre
Janakpuri, New Delhi - 110058
India



Allied Machine & Engineering is a worldwide leader in holemaking and finishing solutions. We are committed to providing practical and dependable solutions to our customers through innovative designs and superior customer and technical support.

We continue to expand our product offering in order to provide new and different solutions. With Field Sales Engineers located around the world, we position ourselves to provide technical support on site, right at your spindle.



ALLIED MACHINE
& ENGINEERING

www.alliedmachine.com

The Foundation

Since 1941, Allied Machine & Engineering has provided dependable and practical holemaking solutions to the world. What was once a small job shop in Ohio is now a worldwide leader in cutting tool technology. With three manufacturing facilities in Ohio, one in Georgia, another in Germany, and headquarters in both the United States and Europe, Allied Machine is positioned to bring innovative solutions and technical expertise directly to the customers' hands.



The Beginning

Harold E. Stokey founded Allied Machine & Engineering to aid the war effort, manufacturing taper bearing lock nuts for the production of M1 tanks. Years later, after a sales meeting gone wrong, Stokey possessed a warehouse stocked with spade drill inserts. He set forth into the industry that would become Allied Machine's thriving identity: holemaking.



The T-A®

When Harold's son, William H. Stokey, became the president and CEO, he developed the Throw Away, or T-A, spade drill insert system. The T-A revolutionized the holemaking industry, launching Allied Machine ahead of the competition. Since then, numerous innovations and advancements have been created from the T-A's inspiration.

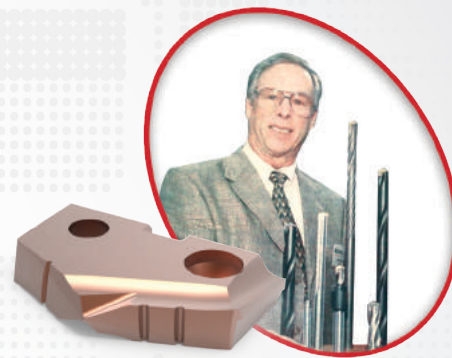

The Innovation

Since the development of the T-A, Allied Machine has expanded its product offering to support a vast range of customer applications, including large diameter and deep hole drilling, boring, reaming, burnishing, porting, and threading.

The People

Allied Machine understands that high quality products are only one facet of success. Our customer support is crucial to what we do, and that's why we make sure the best engineers and customer service associates are in place to assist our customers around the world.

The Future

With over 75 years of experience, Allied Machine has encountered the challenges of growth and success. By investing in cutting edge technology and the brightest and sharpest minds, our knowledge and capabilities continue to expand and grow every day.



Steve Stokey
Executive Vice President

William H. Stokey
President and CEO

Mike Stokey
Executive Vice President



Replaceable Insert Drills

- Reduce costs by decreasing set-up time and utilizing a single holder for the lives of multiple inserts
- Provide flexibility to quickly switch between inserts with different geometries
- Products:
 - GEN3SYS® XT | GEN3SYS® XT Pro
 - Original T-A® | GEN2 T-A®
 - High Performance | Universal



Indexable Insert Drills

- Protect your investment and reduce your inventory with replaceable cartridges that allow the same holder to be used repeatedly
- Indexable inserts increase productivity and tool life while reducing costs
- Products:
 - 4TEX™ Drill
 - Revolution Drill®
 - Opening Drill®

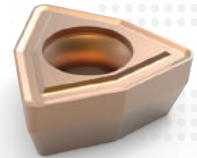

Replaceable / Indexable Insert Drills

- Allow for higher spindle speeds and take advantage of the power curve on modern CNC machines
- Achieve maximum penetration rates in deep hole drilling applications
- Holders cover a range of sizes with the replaceable heads determining the cutting diameter
- Products:
 - APX Drill



Solid Carbide Drills

- Offer greater strength and stability when drilling tougher materials
- Available in diameters from 3mm - 20mm
- Can be made-to-order specifically for your application (Superion™ quoted specials)
 - ASC 320®
 - Superion™





Structural Steel Solutions

- Deliver outstanding performance and durability in structural steel applications
- Designed to produce optimal results in difficult-to-machine materials
- Available in multiple lengths and diameters
- T-A® style drills have different insert geometry options to improve performance depending on material
- Products:
 - Original T-A® | GEN2 T-A®
 - GEN3SYS® XT Pro

BTA (STS) Machining Solutions

- The internal ejection system flushes chips and debris from the hole with no interference to the cutting process
- Utilizes the advantages of the T-A® drill insert
- Designed to significantly increase penetration rates over brazed heads and traditional gun drills
- Products:
 - BT-A Drill



Hydraulic Port Contour Cutters

- Save significant time and money by performing four processes in one step
- Replaceable insert design reduces costs, inventory, and set-up times
- Available in 4 industry specifications:
 - Imperial: SAE J-1926
 - Metric: ISO 6149-1:2006
 - Military: SAE AS5202
 - John Deere: JDS-G173.1
- Products:
 - AccuPort 432®



Enhanced Special Drilling Capabilities

- Allied Machine Engineers are available to meet with you to evaluate your application and recommend the best solution for you
- Special drilling solutions can incorporate advanced features such as adjustable diameter locations, multiple steps, additional coolant designs, special lengths and diameters, and more
- Special drills can drastically reduce your cost-per-hole and increase your overall productivity by eliminating multiple processes and increasing tool life



WOHLHAUPTER®

High Precision Boring Systems

- Designs available for high volume applications that increase rigidity to improve performance
- Versatile boring heads that are flexible with changing applications while maintaining excellent performance
- Provides high precision with absolute repeatability to ensure every part is held to tolerance
- Offers an industry leading modular shank connection that maintains rigidity and reduces inventory on your boring system
- Available with both digital and analog settings
- Products:
 - Wohlhaupter® Boring Tools



3E TECH



CRITERION™

Modular Boring Systems

- The modular capabilities are ideal for use across multiple different projects
- Offers versatile boring heads suitable for all job shops and tooling rooms
- Provides an economical solution for low volume and/or short-term production applications
- Offers both rough and finish boring solutions
- Products:
 - Criterion™ Boring Tools

S.C.A.M.I.®

Expandable Reaming Solutions

- Expandable cutting diameters accommodate for wear, which extends tool life
- Replaceable cutting heads and rings reduce waste and improve production time versus solid high speed steel and carbide reamers
- Hold tight tolerances to ensure processes are performed to accurate specifications
- Reduce tooling costs because many items are available for recondition
- Products:
 - ALVAN® Reamers



S.C.A.M.I.®

Roller Burnishing Solutions

- Produce excellent surface finishes
- Provide accurate size control
- Increase surface hardness
- Solutions for both through hole and blind hole applications
- Products:
 - S.C.A.M.I.® Roller Burnishing Tools



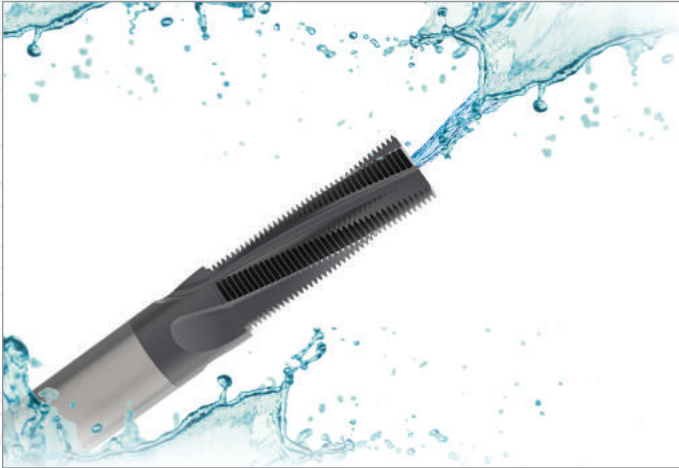

Solid Carbide Thread Mills

- Available with coolant through options
- Cover a wide range of thread forms
- Provide optimal solutions for both high production projects and short-run applications
- Products
 - AccuThread™ 856
 - AccuThread™ T3
 - ThreadMills USA



Replaceable Insert Thread Mills

- 3 insert lengths are available that cover a wide range of thread forms
- Holders can utilize inserts with different pitches and thread forms
- Repeatability is achieved by both the bolt-in style and the pin style locking systems
- Increase tool life by 25 - 50% with Allied Machine's AM210® coating
- Products
 - AccuThread™ 856: Bolt-in Style
 - AccuThread™ 856: Pin Style



SPECIAL CAPABILITIES

When it comes to designing and developing special solutions for customers, Allied Machine is the top choice. If your application requires special tooling, give us a call. Our engineered specials are developed by the brightest engineers in the industry. Most of our standard tooling can be altered as specials, or we can create entirely new concepts for particularly unique applications.

One special tooling solution is Insta-Quote™, the online system that allows you to design your own special tooling 24/7. Receive a quote and drawings within minutes just by following the steps.

And with the addition of Superior™ technology and capabilities, we can customize made-to-order solid carbide tools to achieve optimal results for your applications.

Whatever your application, Allied Machine has the answer.



Insta-Quote™ 

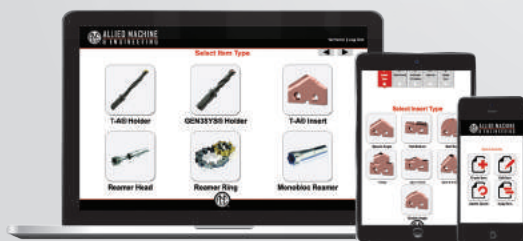

 SUPERION™



Criterion® Modular Boring Systems

Cri-Twin® | Cri-Bore® | Large Cri-Bore® | CB Style | CBER® | Cri-Bar | Competitor Connections



CRITERION™

Boring has never been more exciting.

Criterion modular boring systems have everything you need for your rough and/or finish boring applications.

The Cri-Twin system is designed for either single or double effective cutting so you can rapidly enlarge your bore or reduce the number of passes required.

The Cri-Bore boring system is designed for finish boring applications. For extremely close tolerance boring, the Cri-Bore micro adjusting boring heads are adjustable in 0.00005" (fifty-millionths).

The CBER boring heads are designed for use in live tooling spindles, right angle heads, or any standard ER collet holder.

This catalog contains important messages that pertain to proper use of the products shown in this catalog. Always read and follow all precautions that use these words.

NOTICE means that failure to follow the precautions in this message could result in damage to the tool or machine but not result in personal injury.

NOTE and **IMPORTANT** are also used. These are important that you read and follow but are not safety-related.

Visit www.alliedmachine.com for the most up-to-date information and procedures.



Aerospace



Agriculture



Automotive



Firearms



Renewable
Energy

Criterion® Modular Boring Systems Contents

Reference Icons

The following icons will appear throughout the catalog to help you navigate between products.

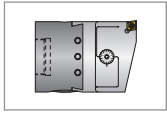

Boring Heads - Insert Holders

Standard and micro adjusting boring heads that use inserts for cutting

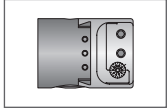

Boring Heads - Boring Bar Holders

Standard and micro adjusting boring heads that use boring bars for cutting

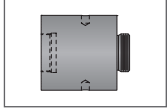

Head-to-Shank Adapters

Extensions and reducers that attach the boring head to the shank

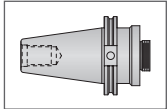

Shanks

A variety of shanks for different machines

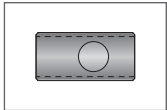

Boring Bar Adapters

For use with boring bar holder boring heads and boring bars

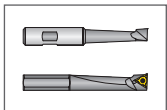

Boring Bars

For use with boring bar holder boring heads or lathe and turning center applications

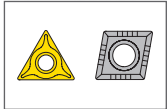

Inserts

For use with insert holder boring heads and boring bars using indexable inserts



Boring Kits

Complete boring kits including boring heads, shanks, bars, and adapters



Setup / Assembly Information

Detailed instructions and information regarding the corresponding part(s)

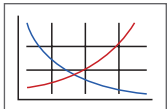

Recommended Cutting Data

Speed and feed recommendations for optimum and safe boring

Introduction Information

Modular Boring System Product Offering	2 - 3
Boring Head Bore Diameter Ranges	4 - 5
Boring Heads Nomenclature	6 - 7

Boring Heads - Insert Holders

Cri-Twin®	8 - 9
Cri-Bore®	10 - 13
Large Cri-Bore® System	14 - 15

Boring Heads - Boring Bar Holders

CB Style	16 - 17
Square and Slotted	18 - 19
Boring and Facing	20 - 21
Tiny Mite	22 - 23
Extensions, Reducers, Adapters	24 - 25

CBER® Boring System

CBER® Boring System	26 - 29
-------------------------------	---------

Cri-Tip Competitor Connections

Cri-Tip Competitor Connections	30 - 35
--	---------

Adjustable Boring Bars

Adjustable Boring Bars	36 - 41
----------------------------------	---------

Shanks

Shanks	42 - 46
------------------	---------

Boring Bars

Boring bars Nomenclature	47
Carbide Style	48 - 53
Insert Style	54 - 59

Inserts

Inserts Nomenclature	60
80° Rhombic	61 - 63
60° Triangle	64 - 66
80° Trigon	67

Boring Kits and Sets

Boring Kits and Sets	68 - 77
--------------------------------	---------

Recommended Cutting Data

Rough Boring	78 - 79
Finish Boring	80 - 81

Set-up Instructions

Cri-Twin Boring Heads	82
Standard / Micro Adjusting Boring Heads	83
Boring and Facing Boring Heads	84 - 86

Criterion Modular Boring Systems

A
DRILLING
B
BORING
C
REAMING
D
BURNISHING
E
THREADING
X
SPECIALS

Shanks

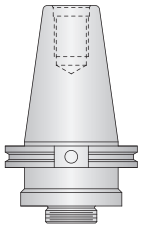

V Flange / DIN 69871

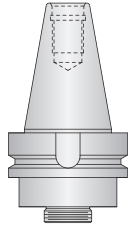

BT Flange

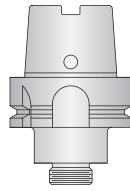

HSK

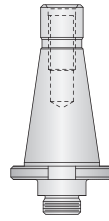

NMBT / DIN 2080

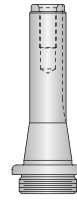

R8



Morse Taper

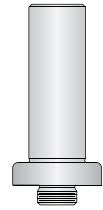

Straight

Adapters



Extension



Reducer

Heads - Insert Holders

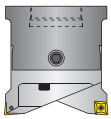

Cri-Twin®



Cri-Bore®

Heads - Bar Holders

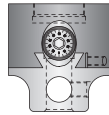

CB Style

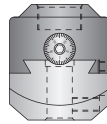

Square

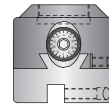

Slotted

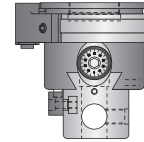

CNC
Boring & Facing

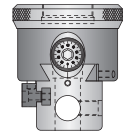

Manual
Boring & Facing

Inserts



80° Rhombic



80° Trigon



60° Triangle

TA Insert Boring Bars



Standard



Steel



Heavy Metal



Carbide Shank



Cross Hole



Boring and Facing

Carbide Boring Bars



Solid Carbide



Qualified Length



Helical Rake

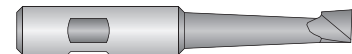

Round Shank

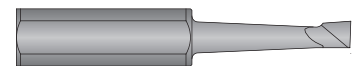

Square Shank

ER Collet Style

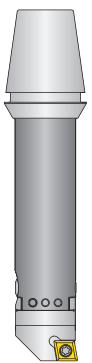

CBER®

Adjustable Bars



Cri-Bar



A
DRILLING
B
BORING
C
REAMING
D
BURNISHING
E
THREADING
X
SPECIALS

Komet® ABS® Connections

Big® Kaiser® Connections

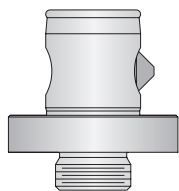

Shank

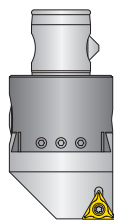

Cri-Tip

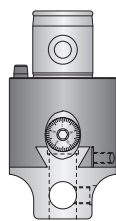

CB Style

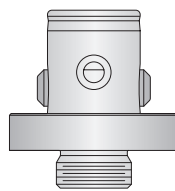

Shank

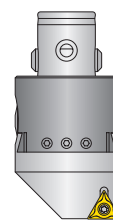

Cri-Tip

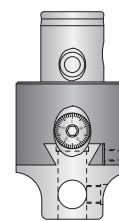

CB Style

Large Cri-Bore® System

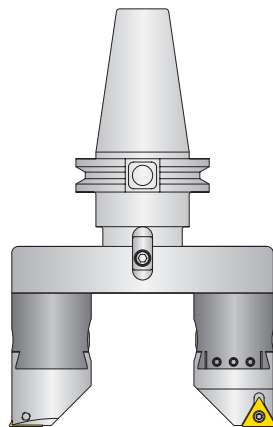

Inner Diameter Bore

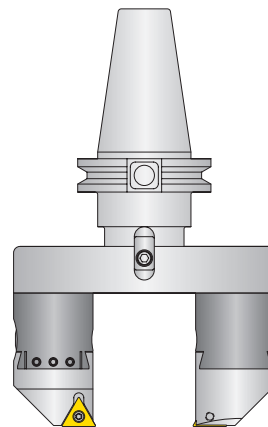

Outer Diameter Bore

Komet® and ABS® are registered trademarks of KOMET Präzisionswerkzeuge Robert Breuning GmbH, Besigheim, Germany, and are not affiliated with Allied Machine & Engineering. Big® and Kaiser® are registered trademarks of Big Daishowa Seiki Co. Ltd., Osaka, Japan, and are not affiliated with Allied Machine & Engineering.

Criterion Boring System Ranges

A DRILLING
B BORING
C REAMING
D BURNISHING
E THREADING
X SPECIALS

Cri-Twin® Modular Boring System

	D_1 Range	Item Description
i	1.100 - 1.500	CT1000
	1.400 - 1.900	CT1250
	1.600 - 2.500	CT1500
	2.100 - 3.100	CT2000
	3.100 - 5.000	CT3000
m	28 - 38	CT025M
	36 - 48	CT032M
	41 - 63	CT038M
	54 - 78	CT050M
	79 - 127	CT076M

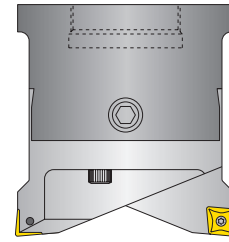

Standard Adjusting

Highlights:

- Remove **2x the amount** of material with a standard and short insert holder
- Rough and finish in the **same operation** with a standard and short insert holder
- Remove material **2x as fast** with two insert holders of the same length

Cri-Bore® Modular Boring System

	D_1 Range	Item Description
i	1.050 - 1.320	CB1000
	1.300 - 1.600	CB1250
	1.585 - 2.700	CB1500
	2.060 - 3.320	CB2000
	3.065 - 5.065	CB3000
	4.180 - 7.380	CB4000
m	27 - 33	CB025M
	33 - 41	CB032M
	41 - 68	CB038M
	53 - 84	CB050M
	78 - 128	CB076M
	104 - 187	CB101M

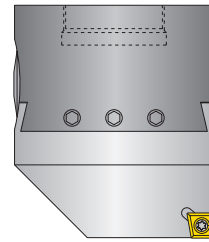

Standard Adjusting

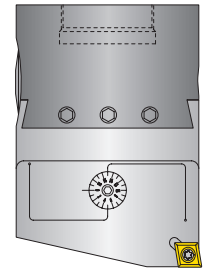

Micro Adjusting

Highlights:

- Standard adjusting is excellent for finish boring
- Micro adjusting is excellent for close tolerance boring
- Total range of micro adjustment is 0.006" (0.150mm) on diameter

Large Cri-Bore® System

	D_1 Range	Item Description
i	0.710 - 7.830	Outer diameter boring
	5.000 - 12.125	Inner diameter boring
m	19 - 198	Outer diameter boring
	127 - 307	Inner diameter boring

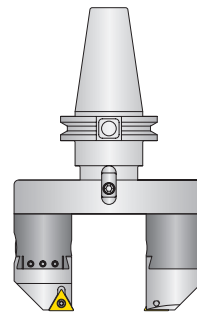

Outer Bore Diameter

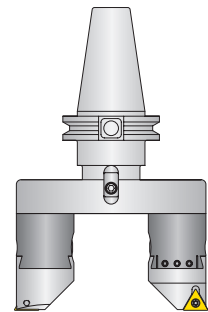

Inner Bore Diameter

i = Imperial (in)
m = Metric (mm)

Criterion Boring System Ranges

CB Style Boring Heads

	Center Hole	Outboard Hole	Cross Hole*	Item Description
i	0.050 - 1.625	–	–	CB-1500B
	0.050 - 1.625	1.000 - 2.500	–	CB-2375A
	0.050 - 1.750	1.312 - 3.000	2.875 - 6.687	CB-202
	0.050 - 3.250	2.000 - 5.125	4.937 - 11.000	CB-203
	0.050 - 3.250	3.000 - 7.000	5.625 - 13.437	CB-204
	1.750 - 5.750	5.500 - 9.500	9.093 - 21.500	CB-206
	0.050 - 1.625	1.000 - 2.500	–	CB-1500MA
	0.050 - 1.750	1.312 - 3.000	–	CB-2500MA
	0.050 - 3.250	2.375 - 5.125	–	CB-3000MA
m	3 - 40	–	–	CB-038MB
	3 - 40	25 - 62	–	CB-038MA
	3 - 40	25 - 62	–	CB-038MC
	3 - 44	35 - 76	73 - 169	CB-050M
	10 - 70	60 - 130	126 - 292	CB-076M
	10 - 113	76 - 178	143 - 341	CB-101M
	3 - 42	34 - 73	–	CB-064MBMA
	10 - 73	60 - 130	–	CB-076MDMA

*NOTICE: Cross hole maximum bore diameter is based upon cross hole bars being secured in the bar holder with at least 2 set screws

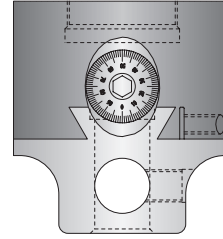

Standard Adjusting

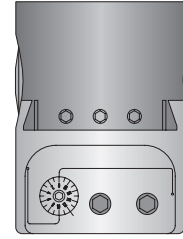

Micro Adjusting

Boring and Facing Heads

	Center Hole	Outboard Hole	Cross Hole*	Item Description
i	0.050 - 2.875	2.375 - 4.750	4.937 - 10.625	BFM-300
m	10 - 76	60 - 120	126 - 288	BFM-076

*NOTICE: Cross hole maximum bore diameter is based upon cross hole bars being secured in the bar holder with at least 2 set screws

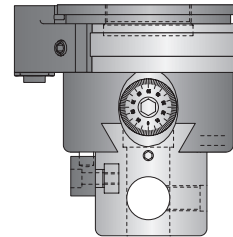

CNC Style

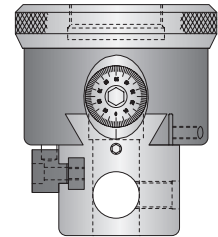

Manual Style

Highlights:

- Ideal for boring, facing, grooving, backfacing, and counterboring operations
- Available in 0.003" per revolution (or fine feed 0.0015" per revolution)
- Clutch automatically disengages the drive when preset stops are contacted
- Head feeds in both directions

Cri-Tip Competitor Connection Boring System

	Bore Diameter Range	Item Description
i	0.050 - 11.000	Big® Kaiser® connection
	0.050 - 11.000	Komet® ABS® connection
m	3 - 130	Big® Kaiser® connection
	3 - 130	Komet® ABS® connection

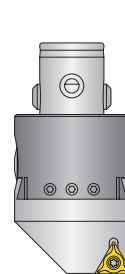

Standard Adjusting

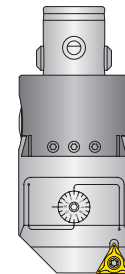

Micro Adjusting

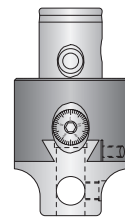

CB Style

i = Imperial (in)
m = Metric (mm)

A DRILLING
B BORING
C REAMING
D BURNISHING
E THREADING
X SPECIALS

Criterion Modular Boring Systems Nomenclature

Criterion Double Effective Boring Heads

CT	2000	–	1
1	2		3

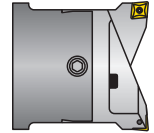

1. Boring Head Style
CT = Cri-Twin®

2. Body Style	
Imperial	Metric
1000 = 1.000"	025M = 25mm
1250 = 1.250"	032M = 32mm
1500 = 1.500"	038M = 38mm
2000 = 2.000"	050M = 50mm
3000 = 3.000"	076M = 76mm

3. Insert Holder Lead Type (Side 1 / Side 2)
0 = Zero / zero
1 = Standard / standard
2 = Standard / short

Criterion Single Effective Boring Heads

CB	2000	–	TP
1	2		3

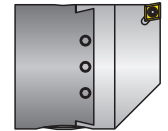

1. Boring Head Style
CB = Cri-Bore®

2. Body Style	
Imperial	Metric
1000 = 1.000"	025M = 25mm
1250 = 1.250"	032M = 32mm
1500 = 1.500"	038M = 38mm
2000 = 2.000"	050M = 50mm
3000 = 3.000"	076M = 76mm
4000 = 4.000"	101M = 101mm

3. Insert Style
TP = TP
CP = CP / CC
TPMA = TP (with micro adjustment)
CPMA = CP / CC (with micro adjustment)

Criterion Boring Bar Holder Heads

CB	–	2000	A
1		2	3

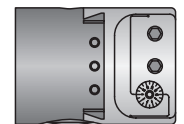

1. Boring Head Style
CB = CB Style
SQ = Square
TMT = Tiny Mite
CSL = Slotted

2. Body Size	
Imperial	Metric
002 = 1.500"	025M = 25mm
152 = 1.500"	032M = 32mm
0750 = 0.750"	038M = 38mm
1000 = 1.000"	050M = 50mm
1500 = 1.500"	076M = 76mm
2000 = 2.000"	101M = 101mm
202 = 2.000"	
3000 = 3.000"	
203 = 3.000"	
204 = 4.000"	
206 = 6.000"	

3. Tool Hole ID	
Imperial	Metric
A = 0.375"	A = 10mm
B = 0.500"	B = 12mm
C = 0.625"	C = 16mm
D = 0.750"	D = 20mm
E = 1.000"	E = 25mm
F = 1.500"	
G = 0.125"	
H = 0.250"	

Criterion Modular Boring Systems Nomenclature

Criterion Competitor Connections

CTP	2000	–	A50	TP
1	2		3	4

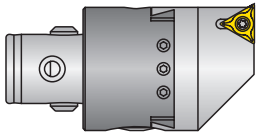

1. Boring Head Style	2. Body Size	3. Adapter Style														
CTP = Cri-Tip	<table border="0"> <tr> <td>Imperial</td> <td>Metric</td> </tr> <tr> <td>1500 = 1.500"</td> <td>038M = 38mm</td> </tr> <tr> <td>2000 = 2.000"</td> <td>050M = 50mm</td> </tr> <tr> <td>3000 = 3.000"</td> <td>076M = 76mm</td> </tr> </table>	Imperial	Metric	1500 = 1.500"	038M = 38mm	2000 = 2.000"	050M = 50mm	3000 = 3.000"	076M = 76mm	<table border="0"> <tr> <td>A40 = Komet® ABS40 connection</td> <td>KA4 = Big® Kaiser® KA4 connection</td> </tr> <tr> <td>A50 = Komet® ABS50 connection</td> <td>KA5 = Big® Kaiser® KA5 connection</td> </tr> <tr> <td>A80 = Komet® ABS80 connection</td> <td>KA7 = Big® Kaiser® KA7 connection</td> </tr> </table>	A40 = Komet® ABS40 connection	KA4 = Big® Kaiser® KA4 connection	A50 = Komet® ABS50 connection	KA5 = Big® Kaiser® KA5 connection	A80 = Komet® ABS80 connection	KA7 = Big® Kaiser® KA7 connection
Imperial	Metric															
1500 = 1.500"	038M = 38mm															
2000 = 2.000"	050M = 50mm															
3000 = 3.000"	076M = 76mm															
A40 = Komet® ABS40 connection	KA4 = Big® Kaiser® KA4 connection															
A50 = Komet® ABS50 connection	KA5 = Big® Kaiser® KA5 connection															
A80 = Komet® ABS80 connection	KA7 = Big® Kaiser® KA7 connection															

4. Boring Head Style	
Imperial	Metric
TP = TP	TP = TP
CP = CP / CC	CP = CP / CC
TPMA = TP (with micro adjustment)	TPMA = TP (with micro adjustment)
CPMA = CP (with micro adjustment)	CPMA = CP (with micro adjustment)
002 = 0.500 tool hole ID	B = 12mm tool hole ID
152 = 0.375 tool hole ID	D = 20mm tool hole ID
202A = 0.375 tool hole ID	MDMA = 20mm tool hole ID (micro adjusting)
202B = 0.500 tool hole ID	
203D = 0.750 tool hole ID	
300MA = 0.750 tool hole ID (micro adjusting)	
DMA = 0.750 tool hole ID (micro adjusting)	

Reference Key

Symbol	Attribute
D_1	Bore diameter range
D_2	Body diameter
D_3	Inner diameter
D_4	Shank diameter
L_1	Overall length
L_{10}	Square length
IC	Inscribed circle
T_1	Insert thickness

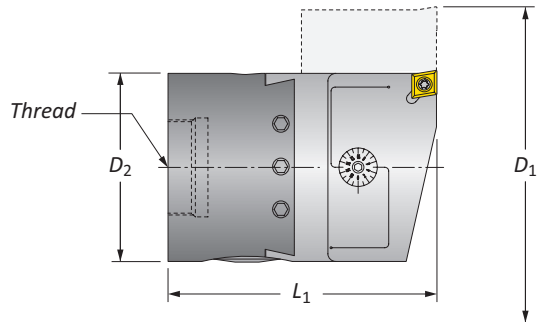

A
DRILLING
B
BORING
C
REAMING
D
BURNISHING
E
THREADING
X
SPECIALS

Cri-Twin® Boring Heads

Standard Adjusting | Diameter Range: 1.100" - 5.000" (28mm - 127mm)

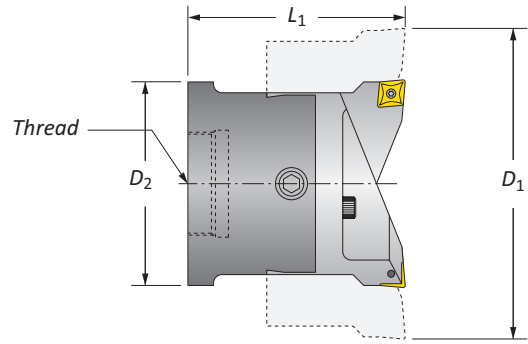

D ₁ Range	Boring Head			Part No.	Insert Holder Type		Inserts		
	L ₁	D ₂	Thread		Side 1	Side 2	IC	T ₁	Style
1.100 - 1.500	1.870	1.00	7/8-20	CT1000-0	Zero Lead	Zero Lead	0.250	0.094	◇ CP or CC
1.100 - 1.500	1.900	1.00	7/8-20	CT1000-1	Standard	Standard	0.250	0.094	◇ CP or CC
1.100 - 1.500	1.900	1.00	7/8-20	CT1000-2	Standard	Short	0.250	0.094	◇ CP or CC
1.400 - 1.900	1.870	1.25	7/8-20	CT1250-0	Zero Lead	Zero Lead	0.250	0.094	◇ CP or CC
1.400 - 1.900	1.900	1.25	7/8-20	CT1250-1	Standard	Standard	0.250	0.094	◇ CP or CC
1.400 - 1.900	1.900	1.25	7/8-20	CT1250-2	Standard	Short	0.250	0.094	◇ CP or CC
1.600 - 2.500	2.570	1.50	7/8-20	CT1500-0	Zero Lead	Zero Lead	0.375	0.156	◇ CP or CC
i 1.600 - 2.500	2.600	1.50	7/8-20	CT1500-1	Standard	Standard	0.375	0.156	◇ CP or CC
1.600 - 2.500	2.600	1.50	7/8-20	CT1500-2	Standard	Short	0.375	0.156	◇ CP or CC
2.100 - 3.100	2.470	2.00	7/8-20	CT2000-0	Zero Lead	Zero Lead	0.375	0.156	◇ CP or CC
2.100 - 3.100	2.500	2.00	7/8-20	CT2000-1	Standard	Standard	0.375	0.156	◇ CP or CC
2.100 - 3.100	2.500	2.00	7/8-20	CT2000-2	Standard	Short	0.375	0.156	◇ CP or CC
3.100 - 5.000	3.170	3.00	1-1/2-18	CT3000-0	Zero Lead	Zero Lead	0.375	0.156	◇ CP or CC
3.100 - 5.000	3.200	3.00	1-1/2-18	CT3000-1	Standard	Standard	0.375	0.156	◇ CP or CC
3.100 - 5.000	3.200	3.00	1-1/2-18	CT3000-2	Standard	Short	0.375	0.156	◇ CP or CC
<hr/>									
28 - 38	47	25	7/8-20	CT025M-0	Zero Lead	Zero Lead	6.35	2.38	◇ CP or CC
28 - 38	48	25	7/8-20	CT025M-1	Standard	Standard	6.35	2.38	◇ CP or CC
28 - 38	48	25	7/8-20	CT025M-2	Standard	Short	6.35	2.38	◇ CP or CC
36 - 48	47	32	7/8-20	CT032M-0	Zero Lead	Zero Lead	6.35	2.38	◇ CP or CC
36 - 48	48	32	7/8-20	CT032M-1	Standard	Standard	6.35	2.38	◇ CP or CC
36 - 48	48	32	7/8-20	CT032M-2	Standard	Short	6.35	2.38	◇ CP or CC
41 - 63	65	38	7/8-20	CT038M-0	Zero Lead	Zero Lead	9.53	3.96	◇ CP or CC
m 41 - 63	66	38	7/8-20	CT038M-1	Standard	Standard	9.53	3.96	◇ CP or CC
41 - 63	66	38	7/8-20	CT038M-2	Standard	Short	9.53	3.96	◇ CP or CC
54 - 78	63	50	7/8-20	CT050M-0	Zero Lead	Zero Lead	9.53	3.96	◇ CP or CC
54 - 78	64	50	7/8-20	CT050M-1	Standard	Standard	9.53	3.96	◇ CP or CC
54 - 78	64	50	7/8-20	CT050M-2	Standard	Short	9.53	3.96	◇ CP or CC
79 - 127	80	76	1-1/2-18	CT076M-0	Zero Lead	Zero Lead	9.53	3.96	◇ CP or CC
79 - 127	81	76	1-1/2-18	CT076M-1	Standard	Standard	9.53	3.96	◇ CP or CC
79 - 127	81	76	1-1/2-18	CT076M-2	Standard	Short	9.53	3.96	◇ CP or CC

Imperial (in) = 0.001" adjustment on diameter
Metric (mm) = 0.02mm adjustment on diameter

Notes:

- CTXXXX-0 units have a 0° lead angle = produce flat bottom
- CTXXXX-1 and -2 units have a 5° lead angle
- CTXXXX-2 units can be offset to remove twice the amount of material (as illustrated)

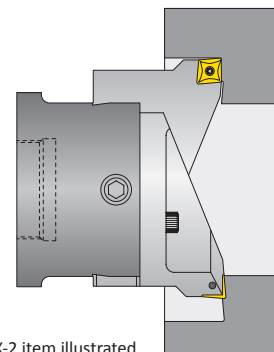

CTXXXX-2 item illustrated

B20: 78 - 79

B20: 42 - 46

B20: 24

B20: 60 - 63

B20: 82

i = Imperial (in)
m = Metric (mm)
Inserts sold separately

A DRILLING
B BORING
C REAMING
D BURNISHING
E THREADING
X SPECIALS

Cri-Twin® Boring Head Replacement Parts

Standard Adjusting

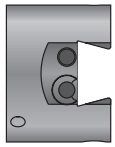
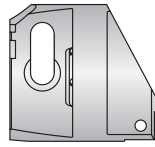
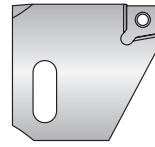
**1** Body**2** Insert Holder 1**3** Insert Holder 2**4** Dial Screw

Head Part No.	Hardware Kit	Components				Torx Screw	Torx Wrench
		1	2	3	4		
CT1000-0	CT1000-HDW	CT1000-BD	CT1000ZRO-IH	CT1000ZRO-IH	DS-MDB0750	TXS-116-1	8T-7FL
CT1000-1	CT1000-HDW	CT1000-BD	CT1000STD-IH	CT1000STD-IH	DS-MDB0750	TXS-116-1	8T-7FL
CT1000-2	CT1000-HDW	CT1000-BD	CT1000STD-IH	CT1000SHT-IH	DS-MDB0750	TXS-116-1	8T-7FL
CT1250-0	CT1250-HDW	CT1250-BD	CT1250ZRO-IH	CT1250ZRO-IH	DS-CT1250	TXS-116-1	8T-7FL
CT1250-1	CT1250-HDW	CT1250-BD	CT1250STD-IH	CT1250STD-IH	DS-CT1250	TXS-116-1	8T-7FL
CT1250-2	CT1250-HDW	CT1250-BD	CT1250STD-IH	CT1250SHT-IH	DS-CT1250	TXS-116-1	8T-7FL
CT1500-0	CT1500-HDW	CT1500-BD	CT1500ZRO-IH	CT1500ZRO-IH	DS-CT1500	TXS-009-1	8T-15
CT1500-1	CT1500-HDW	CT1500-BD	CT1500STD-IH	CT1500STD-IH	DS-CT1500	TXS-009-1	8T-15
CT1500-2	CT1500-HDW	CT1500-BD	CT1500STD-IH	CT1500SHT-IH	DS-CT1500	TXS-009-1	8T-15
CT2000-0	CT2000-HDW	CT2000-BD	CT2000ZRO-IH	CT2000ZRO-IH	DS-CT2000	TXS-009-1	8T-15
CT2000-1	CT2000-HDW	CT2000-BD	CT2000STD-IH	CT2000STD-IH	DS-CT2000	TXS-009-1	8T-15
CT2000-2	CT2000-HDW	CT2000-BD	CT2000SHT-IH	CT2000STD-IH	DS-CT2000	TXS-009-1	8T-15
CT3000-0	CT3000-HDW	CT3000-BD	CT3000ZRO-IH	CT3000ZRO-IH	DS-CT3000	TXS-009-1	8T-15
CT3000-1	CT3000-HDW	CT3000-BD	CT3000STD-IH	CT3000STD-IH	DS-CT3000	TXS-009-1	8T-15
CT3000-2	CT3000-HDW	CT3000-BD	CT3000STD-IH	CT3000SHT-IH	DS-CT3000	TXS-009-1	8T-15
CT025M-0	CT025M-HDW	CT025M-BD	CT025MZRO-IH	CT025MZRO-IH	DS-MDB20M	TXS-116-1	8T-7FL
CT025M-1	CT025M-HDW	CT025M-BD	CT025MSTD-IH	CT025MSTD-IH	DS-MDB20M	TXS-116-1	8T-7FL
CT025M-2	CT025M-HDW	CT025M-BD	CT025MSTD-IH	CT025MSHT-IH	DS-MDB20M	TXS-116-1	8T-7FL
CT032M-0	CT032M-HDW	CT032M-BD	CT032MZRO-IH	CT032MZRO-IH	DS-CT032M	TXS-116-1	8T-7FL
CT032M-1	CT032M-HDW	CT032M-BD	CT032MSTD-IH	CT032MSTD-IH	DS-CT032M	TXS-116-1	8T-7FL
CT032M-2	CT032M-HDW	CT032M-BD	CT032MSTD-IH	CT032MSHT-IH	DS-CT032M	TXS-116-1	8T-7FL
CT038M-0	CT038M-HDW	CT038M-BD	CT038MZRO-IH	CT038MZRO-IH	DS-CT038M	TXS-009-1	8T-15
CT038M-1	CT038M-HDW	CT038M-BD	CT038MSTD-IH	CT038MSTD-IH	DS-CT038M	TXS-009-1	8T-15
CT038M-2	CT038M-HDW	CT038M-BD	CT038MSTD-IH	CT038MSHT-IH	DS-CT038M	TXS-009-1	8T-15
CT050M-0	CT050M-HDW	CT050M-BD	CT050MZRO-IH	CT050MZRO-IH	DS-CT050M	TXS-009-1	8T-15
CT050M-1	CT050M-HDW	CT050M-BD	CT050MSTD-IH	CT050MSTD-IH	DS-CT050M	TXS-009-1	8T-15
CT050M-2	CT050M-HDW	CT050M-BD	CT050MSTD-IH	CT050MSHT-IH	DS-CT050M	TXS-009-1	8T-15
CT076M-0	CT076M-HDW	CT076M-BD	CT076MZRO-IH	CT076MZRO-IH	DS-CT076M	TXS-009-1	8T-15
CT076M-1	CT076M-HDW	CT076M-BD	CT076MSTD-IH	CT076MSTD-IH	DS-CT076M	TXS-009-1	8T-15
CT076M-2	CT076M-HDW	CT076M-BD	CT076MSTD-IH	CT076MSHT-IH	DS-CT076M	TXS-009-1	8T-15

i = Imperial (in)

m = Metric (mm)

Screws sold in multiples of 10

Cri-Bore® Boring Heads

Standard Adjusting | Diameter Range: 1.050" - 7.380" (27mm - 187mm)

A
DRILLING

B
BORING

C
REAMING

D
BURNISHING

F
THREADING

X
SPECIALS

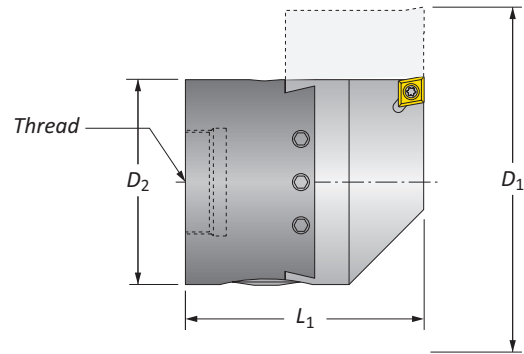

D ₁ Range	Boring Head			Part No.	Pin Spanner Wrench	Insert		
	L ₁	D ₂	Thread			IC	T ₁	Style
1.050 - 1.320	1.980	1.000	7/8-20	CB1000-TP	CB1000-PSW	0.250	0.094	▲ TP
1.050 - 1.320	1.980	1.000	7/8-20	CB1000-CP	CB1000-PSW	0.250	0.094	◆ CP or CC
1.300 - 1.600	2.210	1.250	7/8-20	CB1250-TP	CB1250-PSW	0.250	0.094	▲ TP
1.300 - 1.600	2.210	1.250	7/8-20	CB1250-CP	CB1250-PSW	0.250	0.094	◆ CP or CC
1.585 - 2.700	2.480	1.500	7/8-20	CB1500-TP	CB1500-PSW	0.375	0.125	▲ TP
1.585 - 2.700	2.480	1.500	7/8-20	CB1500-CP	CB1500-PSW	0.375	0.156	◆ CP or CC
i 2.060 - 3.320	2.735	2.000	7/8-20	CB2000-TP	CB2000-PSW	0.375	0.125	▲ TP
2.060 - 3.320	2.735	2.000	7/8-20	CB2000-CP	CB2000-PSW	0.375	0.156	◆ CP or CC
3.065 - 5.065	3.465	3.000	1-1/2-18	CB3000-TP	CB3000-PSW	0.375	0.125	▲ TP
3.065 - 5.065	3.465	3.000	1-1/2-18	CB3000-CP	CB3000-PSW	0.375	0.156	◆ CP or CC
4.100 - 7.300	3.970	4.000	1-1/2-18	CB4000-TP	CB4000-PSW	0.375	0.156	▲ TP
4.180 - 7.380	3.970	4.000	1-1/2-18	CB4000-CP	CB4000-PSW	0.500	0.188	◆ CP or CC
27 - 33	50	25	7/8-20	CB025M-TP	CB1000-PSW	6.35	2.38	▲ TP
27 - 33	50	25	7/8-20	CB025M-CP	CB1000-PSW	6.35	2.38	◆ CP or CC
33 - 41	56	32	7/8-20	CB032M-TP	CB1250-PSW	6.35	2.38	▲ TP
33 - 41	56	32	7/8-20	CB032M-CP	CB1250-PSW	6.35	2.38	◆ CP or CC
41 - 68	63	38	7/8-20	CB038M-TP	CB1500-PSW	9.53	3.18	▲ TP
41 - 68	63	38	7/8-20	CB038M-CP	CB1500-PSW	9.53	3.96	◆ CP or CC
53 - 84	69	50	7/8-20	CB050M-TP	CB2000-PSW	9.53	3.18	▲ TP
53 - 84	69	50	7/8-20	CB050M-CP	CB2000-PSW	9.53	3.96	◆ CP or CC
78 - 128	88	76	1-1/2-18	CB076M-TP	CB3000-PSW	9.53	3.18	▲ TP
78 - 128	88	76	1-1/2-18	CB076M-CP	CB3000-PSW	9.53	3.96	◆ CP or CC
104 - 185	101	101	1-1/2-18	CB101M-TP	CB4000-PSW	9.53	3.18	▲ TP
106 - 187	101	101	1-1/2-18	CB101M-CP	CB4000-PSW	12.70	4.76	◆ CP or CC

Imperial (in) = 0.001" adjustment on diameter
Metric (mm) = 0.02mm adjustment on diameter

B20: 80 - 81

B20: 42 - 46

B20: 24

B20: 60 - 67

B20: 83

i = Imperial (in)
m = Metric (mm)
Inserts sold separately

Cri-Bore® Boring Head Replacement Parts

Standard Adjusting

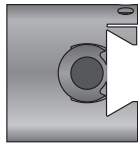
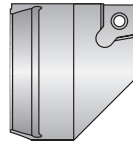
**1** Body**2** Insert Holder**3** Dial Screw

Head Part No.	Hardware Kit	Components				
		1	2	3	Torx Screw	Torx Wrench
CB1000-TP	CB1000-HDW	CB1000-BD	CB1000TP-IH	DS-MDB1000	TXS-116-1	8T-7
CB1000-CP	CB1000-HDW	CB1000-BD	CB1000CP-IH	DS-MDB1000	TXS-116-1	8T-7
CB1250-TP	CB1250-HDW	CB1250-BD	CB1250TP-IH	DS-MDB1000	TXS-116-1	8T-7
CB1250-CP	CB1250-HDW	CB1250-BD	CB1250CP-IH	DS-MDB1000	TXS-116-1	8T-7
CB1500-TP	CB1500-HDW	CB1500-BD	CB1500TP-IH	DS-CB2	TXS-100-1	8T-20
CB1500-CP	CB1500-HDW	CB1500-BD	CB1500CP-IH	DS-CB2	TXS-009-1	8T-15
CB2000-TP	CB2000-HDW	CB2000-BD	CB2000TP-IH	DS-CB2	TXS-100-1	8T-20
CB2000-CP	CB2000-HDW	CB2000-BD	CB2000CP-IH	DS-CB2	TXS-009-1	8T-15
CB3000-TP	CB3000-HDW	CB3000-BD	CB3000TP-IH	DS-CB3	TXS-100-1	8T-20
CB3000-CP	CB3000-HDW	CB3000-BD	CB3000CP-IH	DS-CB3	TXS-009-1	8T-15
CB4000-TP	CB4000-HDW	CB4000-BD	CB4000TP-IH	DS-CB4	TXS-100-1	8T-15FL
CB4000-CP	CB4000-HDW	CB4000-BD	CB4000CP-IH	DS-CB4	TXS-119-1	8T-20FL
CB025M-TP	CB025M-HDW	CB025M-BD	CB025MTP-IH	DS-MDB25M	TXS-116-1	8T-7
CB025M-CP	CB025M-HDW	CB025M-BD	CB025MCP-IH	DS-MDB25M	TXS-116-1	8T-7
CB032M-TP	CB032M-HDW	CB032M-BD	CB032MTP-IH	DS-MDB32M	TXS-116-1	8T-7
CB032M-CP	CB032M-HDW	CB032M-BD	CB032MCP-IH	DS-MDB32M	TXS-116-1	8T-7
CB038M-TP	CB038M-HDW	CB038M-BD	CB038MTP-IH	DS-CB050M	TXS-100-1	8T-20
CB038M-CP	CB038M-HDW	CB038M-BD	CB038MCP-IH	DS-CB050M	TXS-009-1	8T-15
CB050M-TP	CB050M-HDW	CB050M-BD	CB050MTP-IH	DS-CB050M	TXS-100-1	8T-20
CB050M-CP	CB050M-HDW	CB050M-BD	CB050MCP-IH	DS-CB050M	TXS-009-1	8T-15
CB076M-TP	CB076M-HDW	CB076M-BD	CB076MTP-IH	DS-CB076M	TXS-100-1	8T-20
CB076M-CP	CB076M-HDW	CB076M-BD	CB076MCP-IH	DS-CB076M	TXS-009-1	8T-15
CB101M-TP	CB101M-HDW	CB101M-BD	CB101MTP-IH	DS-CB101M	TXS-100-1	8T-15FL
CB101M-CP	CB101M-HDW	CB101M-BD	CB101MCP-IH	DS-CB101M	TXS-119-1	8T-20FL

i = Imperial (in)

m = Metric (mm)

Screws sold in multiples of 10

A **Cri-Bore® Boring Heads**

Micro Adjusting | Diameter Range: 1.050" - 5.065" (27mm - 128mm)

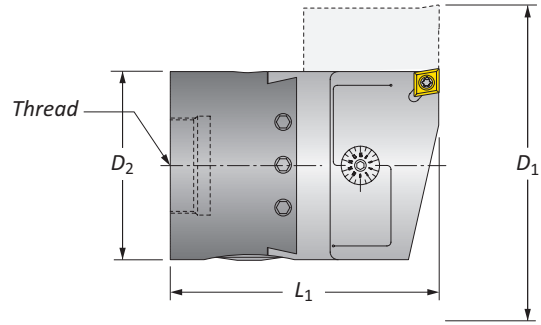

D ₁ Range	Boring Head			Part No.	Pin Spanner Wrench	Insert		
	L ₁	D ₂	Thread			IC	T ₁	Style
1.050 - 1.320	2.580	1.000	7/8-20	CB1000-TPMA	CB1000-PSW	0.250	0.094	▲ TP
1.050 - 1.320	2.580	1.000	7/8-20	CB1000-CPMA	CB1000-PSW	0.250	0.094	◆ CP or CC
1.300 - 1.600	2.810	1.250	7/8-20	CB1250-TPMA	CB1250-PSW	0.250	0.094	▲ TP
1.300 - 1.600	2.810	1.250	7/8-20	CB1250-CPMA	CB1250-PSW	0.250	0.094	◆ CP or CC
1.585 - 2.700	3.180	1.500	7/8-20	CB1500-TPMA	CB1500-PSW	0.375	0.125	▲ TP
1.585 - 2.700	3.180	1.500	7/8-20	CB1500-CPMA	CB1500-PSW	0.375	0.156	◆ CP or CC
2.060 - 3.320	3.530	2.000	7/8-20	CB2000-TPMA	CB2000-PSW	0.375	0.125	▲ TP
2.060 - 3.320	3.530	2.000	7/8-20	CB2000-CPMA	CB2000-PSW	0.375	0.156	◆ CP or CC
3.065 - 5.065	4.090	3.000	1-1/2-18	CB3000-TPMA	CB3000-PSW	0.375	0.125	▲ TP
3.065 - 5.065	4.090	3.000	1-1/2-18	CB3000-CPMA	CB3000-PSW	0.375	0.156	◆ CP or CC
i								
27 - 33	65	25	7/8-20	CB025M-TPMA	CB1000-PSW	6.35	2.38	▲ TP
27 - 33	65	25	7/8-20	CB025M-CPMA	CB1000-PSW	6.35	2.38	◆ CP or CC
33 - 41	71	32	7/8-20	CB032M-TPMA	CB1250-PSW	6.35	2.38	▲ TP
33 - 41	71	32	7/8-20	CB032M-CPMA	CB1250-PSW	6.35	2.38	◆ CP or CC
41 - 68	81	38	7/8-20	CB038M-TPMA	CB1500-PSW	9.53	3.18	▲ TP
41 - 68	81	38	7/8-20	CB038M-CPMA	CB1500-PSW	9.53	3.96	◆ CP or CC
53 - 84	90	50	7/8-20	CB050M-TPMA	CB2000-PSW	9.53	3.18	▲ TP
53 - 84	90	50	7/8-20	CB050M-CPMA	CB2000-PSW	9.53	3.96	◆ CP or CC
78 - 128	104	76	1-1/2-18	CB076M-TPMA	CB3000-PSW	9.53	3.18	▲ TP
78 - 128	104	76	1-1/2-18	CB076M-CPMA	CB3000-PSW	9.53	3.96	◆ CP or CC

Imperial (in) = 0.00005" adjustment on diameter
 Metric (mm) = 0.001mm adjustment on diameter

C REAMING
D BURNISHING

F THREADING
X SPECIALS

B20: 80 - 81 B20: 42 - 46 B20: 24 B20: 60 - 67 B20: 83

i = Imperial (in)
m = Metric (mm)
 Inserts sold separately

Cri-Bore® Boring Head Replacement Parts

Micro Adjusting

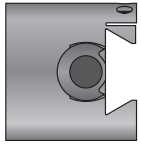

1 Body

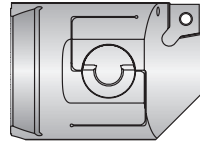

2 Insert Holder



3 Dial Screw



4 Micro Dial Screw

Head Part No.	Hardware Kit	Components				Wedge	Torx Screw	Torx Wrench
		1	2	3	4			
CB1000-TPMA	CB1000-HDW	CB1000-BD	CB1000TPMA-IH	DS-MDB1000	DS-MA1500	MAW-1000	TXS-116-1	8T-7
CB1000-CPMA	CB1000-HDW	CB1000-BD	CB1000CPMA-IH	DS-MDB1000	DS-MA1500	MAW-1000	TXS-116-1	8T-7
CB1250-TPMA	CB1250-HDW	CB1250-BD	CB1250TPMA-IH	DS-MDB1000	DS-MA1500	MAW-1000	TXS-116-1	8T-7
CB1250-CPMA	CB1250-HDW	CB1250-BD	CB1250CPMA-IH	DS-MDB1000	DS-MA1500	MAW-1000	TXS-100-1	8T-20
CB1500-TPMA	CB1500-HDW	CB1500-BD	CB1500TPMA-IH	DS-CB2	DS-MA2500	MAW-2000	TXS-100-1	8T-20
CB1500-CPMA	CB1500-HDW	CB1500-BD	CB1500CPMA-IH	DS-CB2	DS-MA2500	MAW-2000	TXS-009-1	8T-15
CB2000-TPMA	CB2000-HDW	CB2000-BD	CB2000TPMA-IH	DS-CB2	DS-MA2500	MAW-2000	TXS-100-1	8T-20
CB2000-CPMA	CB2000-HDW	CB2000-BD	CB2000CPMA-IH	DS-CB2	DS-MA2500	MAW-2000	TXS-009-1	8T-15
CB3000-TPMA	CB3000-HDW	CB3000-BD	CB3000TPMA-IH	DS-CB3	DS-MA2500	MAW-2000	TXS-100-1	8T-20
CB3000-CPMA	CB3000-HDW	CB3000-BD	CB3000CPMA-IH	DS-CB3	DS-MA2500	MAW-2000	TXS-009-1	8T-15
CB025M-TPMA	CB025M-HDW	CB025M-BD	CB025MTPMA-IH	DS-MDB25M	DS-MA038M	MAW-1000	TXS-116-1	8T-7
CB025M-CPMA	CB025M-HDW	CB025M-BD	CB025MCPMA-IH	DS-MDB25M	DS-MA038M	MAW-1000	TXS-116-1	8T-7
CB032M-TPMA	CB032M-HDW	CB032M-BD	CB032MTPMA-IH	DS-MDB32M	DS-MA038M	MAW-1000	TXS-116-1	8T-7
CB032M-CPMA	CB032M-HDW	CB032M-BD	CB032MCPMA-IH	DS-MDB32M	DS-MA038M	MAW-1000	TXS-116-1	8T-7
CB038M-TPMA	CB038M-HDW	CB038M-BD	CB038MTPMA-IH	DS-CB050M	DS-MA064M	MAW-2000	TXS-100-1	8T-20
CB038M-CPMA	CB038M-HDW	CB038M-BD	CB038MCPMA-IH	DS-CB050M	DS-MA064M	MAW-2000	TXS-009-1	8T-15
CB050M-TPMA	CB050M-HDW	CB050M-BD	CB050MTPMA-IH	DS-CB050M	DS-MA064M	MAW-2000	TXS-100-1	8T-20
CB050M-CPMA	CB050M-HDW	CB050M-BD	CB050MCPMA-IH	DS-CB050M	DS-MA064M	MAW-2000	TXS-009-1	8T-15
CB076M-TPMA	CB076M-HDW	CB076M-BD	CB076MTPMA-IH	DS-CB076M	DS-MA064M	MAW-2000	TXS-100-1	8T-20
CB076M-CPMA	CB076M-HDW	CB076M-BD	CB076MCPMA-IH	DS-CB076M	DS-MA064M	MAW-2000	TXS-009-1	8T-15

i = Imperial (in)

m = Metric (mm)

Screws sold in multiples of 10

Large Cri-Bore® System

Bore ID Range: 5.000" - 12.125" (127.0mm - 307.9mm) | Bore OD Range: 0.710" - 7.830" (18.1mm - 198.8mm)

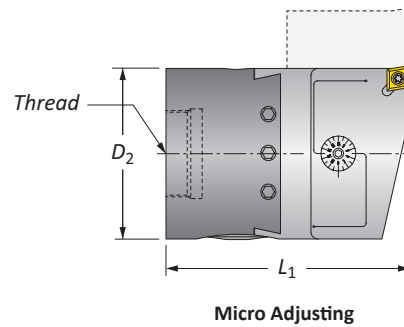
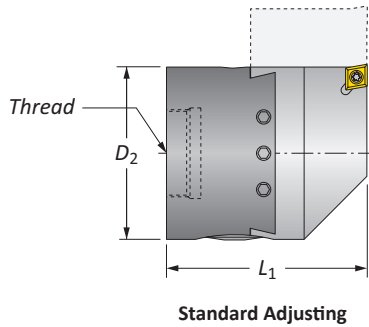
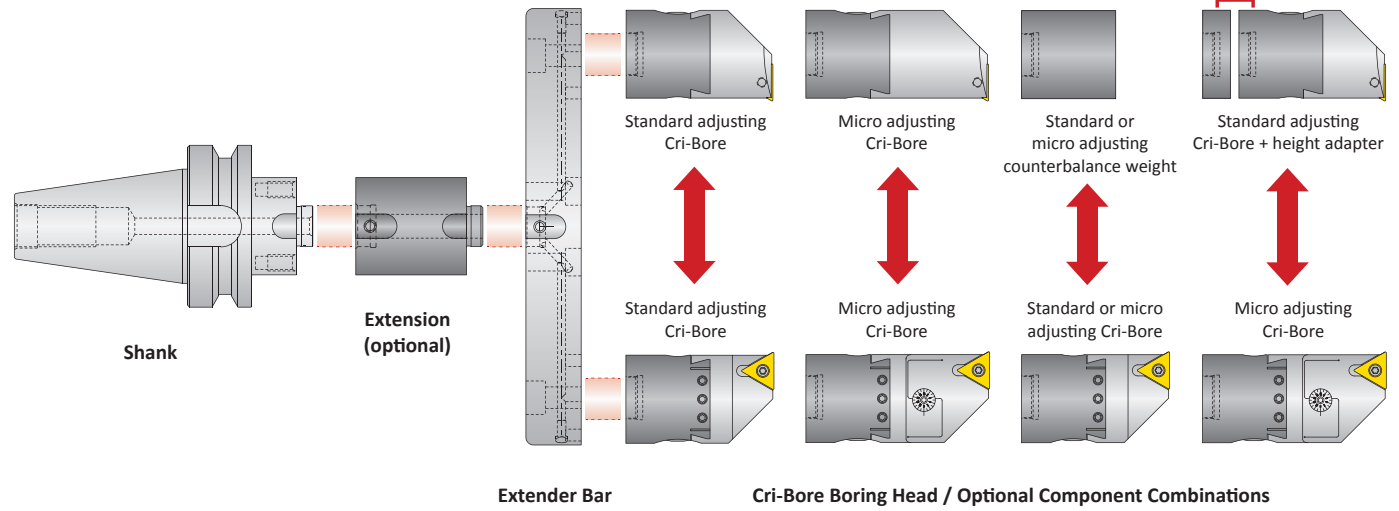

Cri-Bore Boring Heads

Adjustment	Boring Head				Insert			
	L_1	D_2	Thread	Part No.	IC	T_1	Style	
i	Standard	2.480	1.500	7/8-20	CB1500-TP	0.375	0.125	▲ TP
	Standard	2.480	1.500	7/8-20	CB1500-CP	0.375	0.156	◆ CP or CC
	Micro	3.180	1.500	7/8-20	CB1500-TPMA	0.375	0.125	▲ TP
	Micro	3.180	1.500	7/8-20	CB1500-CPMA	0.375	0.156	◆ CP or CC
m	Standard	63	38	7/8-20	CB038M-TP	0.375	0.125	▲ TP
	Standard	63	38	7/8-20	CB038M-CP	0.375	0.156	◆ CP or CC
	Micro	81	38	7/8-20	CB038M-TPMA	0.375	0.125	▲ TP
	Micro	81	38	7/8-20	CB038M-CPMA	0.375	0.156	◆ CP or CC

Imperial (in) Standard = 0.001" adjustment on diameter
Imperial (in) Micro = 0.00005" adjustment on diameter

Metric (mm) Standard = 0.02mm adjustment on diameter
Metric (mm) Micro = 0.001mm adjustment on diameter

Large Cri-Bore Extensions

	Dimensions		Part No.
	D_1	L_1	
i	1.50	1.50	LCB1500-IA1500
	1.50	3.00	LCB1500-IA3000
	1.50	4.50	LCB1500-IA4500

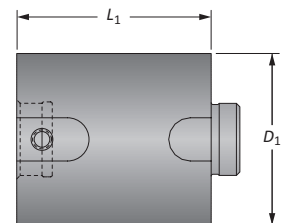

NOTICE: Only one extension can be used per boring head. Extensions cannot be combined.

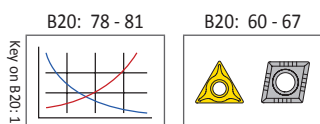

i = Imperial (in)
m = Metric (mm)
Inserts sold separately

Large Cri-Bore® System

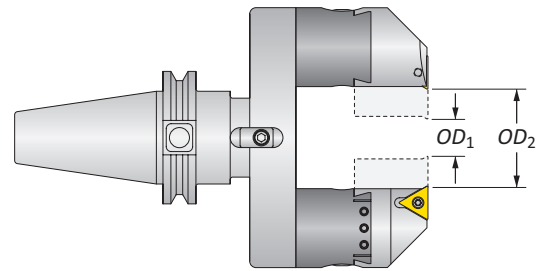
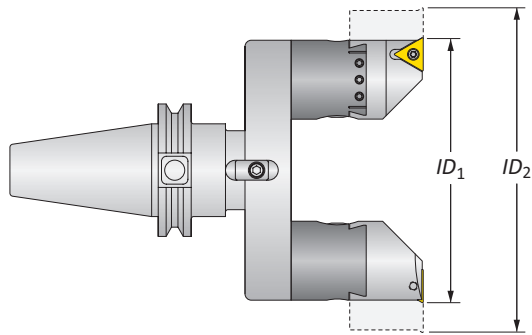

Large Cri-Bore Extender Bars

Imperial (in)				Metric (mm)				Part No.
ID ₁	ID ₂	OD ₁	OD ₂	ID ₁	ID ₂	OD ₁	OD ₂	
5.000	6.125	0.710	1.830	127.0	155.5	18.1	46.4	LCB1500-56EBK
6.000	7.125	1.710	2.830	152.4	180.9	43.5	71.8	LCB1500-67EBK
7.000	8.125	2.710	3.830	177.8	206.3	68.9	97.2	LCB1500-78EBK
8.000	9.125	3.710	4.830	203.2	231.7	94.3	122.6	LCB1500-89EBK
9.000	10.125	4.710	5.830	228.6	257.1	119.7	148.0	LCB1500-910EBK
10.000	11.125	5.710	6.830	254.0	282.5	145.1	173.4	LCB1500-1011EBK
11.000	12.125	6.710	7.830	279.4	307.9	170.5	198.8	LCB1500-1112EBK

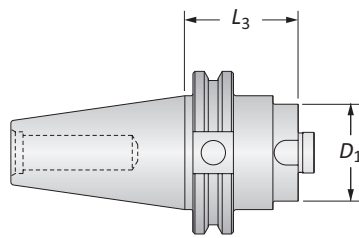

CV40 Shank

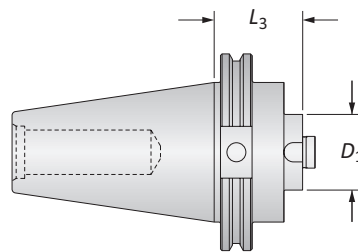

CV50 Shank

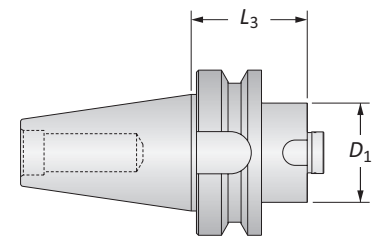

BT40 Shank

Large Cri-Bore Shanks

i	Shank		Part No.
	L ₃	Taper	
	1.75	40 V-Flange	LCB1500-CV40
	1.75	50 V-Flange	LCB1500-CV50
	1.75	40 BT-Flange	LCB1500-BT40
	1.75	HSK63A	LCB1500-HSK63A

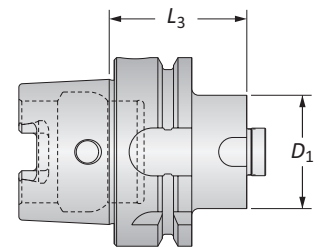

HSK63 Shank

Large Cri-Bore Optional Components

Part No.	Description	Notes
LCB1500-CBW	Counterbalance weight	Recommended when using a single CB1500 (standard adjusting) boring head
LCB1500-CBWTA	Counterbalance weight	Recommended when using a single CB1500-MA (micro-adjusting) boring head
LCB1500-HA	Height adapter	Required when using a CB1500 boring head in combination with a CB1500-MA boring head

NOTICE: The Large Cri-Bore (LCB) System can be used with a single Cri-Bore boring head. This configuration will result in increased imbalance and will affect the tool's performance and/or spindle damage. A counterbalance weight is recommended to balance the tool. Factory technical assistance is available through our Application Engineering department.

i = Imperial (in)
m = Metric (mm)

CB Style Boring Heads

Standard Adjusting | Micro Adjusting | Bore Diameter Range: 0.050" - 21.500" (3mm - 341mm)

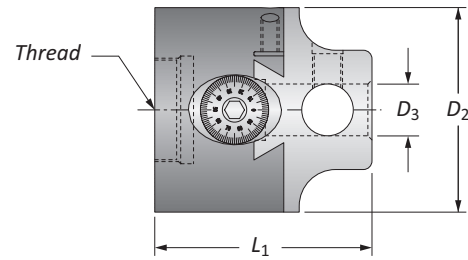

Standard Adjusting

	Bore Diameter Range			Boring Head					Part No.	Pin Spanner Wrench	Cross Hole Bar
	Center Hole	Outboard Hole	Cross Hole*	D ₂	D ₃	L ₁	Thread	Offset			
	0.050 - 1.625	-	-	1.500	0.375	2.500	7/8-20	0.562	CB-2375A	CB1500-PSW	-
	0.050 - 1.625	-	-	1.500	0.500	2.500	7/8-20	0.562	CB-1500B	CB1500-PSW	-
i	0.050 - 1.750	1.312 - 3.000	2.875 - 6.687	2.000	0.375	2.406	7/8-20	0.625	CB-202A	CB2000-PSW	CHB-0500
	0.050 - 1.750	1.312 - 3.000	2.875 - 6.687	2.000	0.500	2.406	7/8-20	0.625	CB-202B	CB2000-PSW	CHB-0500
	0.050 - 3.250	2.375 - 5.125	4.937 - 11.000	3.000	0.750	3.156	1-1/2-18	1.000	CB-203D	CB3000-PSW	CHB-0750
	0.050 - 4.500	3.000 - 7.000	5.625 - 13.437	4.000	1.000	3.867	1-1/2-18	1.625	CB-204E	CB4000-PSW	CHB-1000
	1.750 - 5.750	5.500 - 9.500	9.093 - 21.500	6.000	1.500	5.500	2-1/4-10	2.000	CB-206F	-	CHB-1500
m	3.00 - 40.00	-	-	38.00	10.00	63.00	7/8-20	14.00	CB-038MA	CB1500-PSW	-
	3.00 - 40.00	-	-	38.00	12.00	63.00	7/8-20	14.00	CB-038MB	CB1500-PSW	-
	3.00 - 44.00	35.00 - 76.00	73.00 - 169.00	50.00	10.00	61.00	7/8-20	16.00	CB-050MA	CB2000-PSW	CHB-012M
	3.00 - 44.00	35.00 - 76.00	73.00 - 169.00	50.00	12.00	61.00	7/8-20	16.00	CB-050MB	CB2000-PSW	CHB-012M
	10.00 - 70.00	60.00 - 130.00	126.00 - 279.00	76.00	20.00	80.00	1-1/2-18	25.00	CB-076MD	CB3000-PSW	CHB-020M
	10.00 - 113.00	76.00 - 178.00	143.00 - 341.00	101.00	25.00	95.00	1-1/2-18	41.00	CB-101ME	CB4000-PSW	CHB-025M

***NOTICE:** Cross hole bars should always be secured in the bar holder with at least two set screws

Imperial (in) = 0.001" adjustment on diameter

Metric (mm) = 0.02mm adjustment on diameter

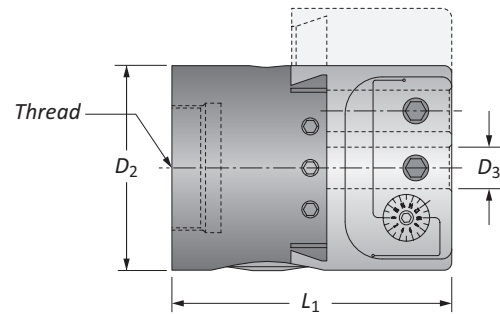

Micro Adjusting

	Bore Diameter Range		Boring Head					Part No.	Pin Spanner Wrench
	Center Hole	Outboard Hole	D ₂	D ₃	L ₁	Thread	Offset		
i	0.050 - 1.625	1.000 - 2.500	1.500	0.375	3.000	7/8-20	0.562	CB-1500AMA	CB1000-PSW
	0.050 - 1.875	1.500 - 3.250	2.500	0.500	3.375	1-1/2-18	0.687	CB-2500BMA	CB2000-PSW
	0.050 - 2.375	2.375 - 5.125	3.000	0.750	3.375	1-1/2-18	1.000	CB-3000DMA	CB3000-PSW
m	3.00 - 42.00	34.00 - 73.00	64.00	12.00	86.00	1-1/2-18	20.00	CB-064MBMA	CB2000-PSW
	10.00 - 73.00	60.00 - 130.00	76.00	20.00	86.00	1-1/2-18	25.00	CB-076MDMA	CB3000-PSW

Imperial (in) = 0.00005" adjustment on diameter

Metric (mm) = 0.001mm adjustment on diameter

B20: 78 - 81 | B20: 42 - 46 | B20: 24 | B20: 25 | B20: 47 - 59 | B20: 60 - 67 | B20: 83

i = Imperial (in)
m = Metric (mm)

CB Style Boring Head Replacement Parts

Standard Adjusting | Micro Adjusting

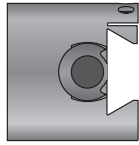

1 Body



2 Bar Holder



3 Dial Screw

Standard Adjusting

	Head Part No.	Hardware Kit	Components		
			1	2	3
i	CB-2375A	CB1500-HDW	CB1500-BD	MB152-BH	DS-CB2
	CB-1500B	CB1500-HDW	CB1500-BD	MB002-BH	DS-CB2
	CB-202A	CB2000-HDW	CB2000-BD	CB202A-BH	DS-CB2
	CB-202B	CB2000-HDW	CB2000-BD	CB202B-BH	DS-CB2
	CB-203D	CB3000-HDW	CB3000-BD	CB203D-BH	DS-CB3
	CB-204E	CB4000-HDW	CB4000-BD	CB204E-BH	DS-CB4
	CB-206F	CB6000-HDW	CB6000-BD	CB206F-BH	DS-CB206
m	CB-038MA	CB038M-HDW	CB038M-BD	CB038MA-BH	DS-CB050M
	CB-038MB	CB038M-HDW	CB038M-BD	CB038MB-BH	DS-CB050M
	CB-050MA	CB050M-HDW	CB050M-BD	CB050MA-BH	DS-CB050M
	CB-050MB	CB050M-HDW	CB050M-BD	CB050MB-BH	DS-CB050M
	CB-076MD	CB076M-HDW	CB076M-BD	CB076MD-BH	DS-CB076M
	CB-101ME	CB101M-HDW	CB101M-BD	CB101ME-BH	DS-CB101M

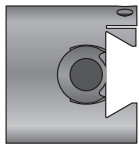

1 Body

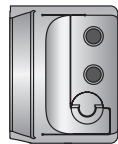

2 Bar Holder



3 Dial Screw



4 Micro Dial Screw

Micro Adjusting

	Head Part No.	Hardware Kit	Components				Wedge
			1	2	3	4	
i	CB-1500AMA	CB1500-HDW	CB1500-BD	CB1500AMA-BH	DS-CB2	DS-MA1500	MAW-1500
	CB-2500BMA	CB2000-HDW	CB2500-BD	CB2500BMA-BH	DS-CB25	DS-MA2500	MAW-2500
	CB-3000DMA	CB3000-HDW	CB3000-BD	CB3000DMA-BH	DS-CB3	DS-MA2500	MAW-3000
m	CB-064MBMA	CB050M-HDW	CB064M-BD	CB064MBMA-BH	DS-CB064M	DS-MA064M	MAW-2000
	CB-076MDMA	CB076M-HDW	CB076M-BD	CB076MDMA-BH	DS-CB076M	DS-MA064M	MAW-2000

i = Imperial (in)

m = Metric (mm)

CB Style Boring Heads

Square Style | Slotted Style | Bore Diameter Range: 0.050" - 4.250"

A DRILLING
B BORING
C REAMING
D BURNISHING
E THREADING
X SPECIALS

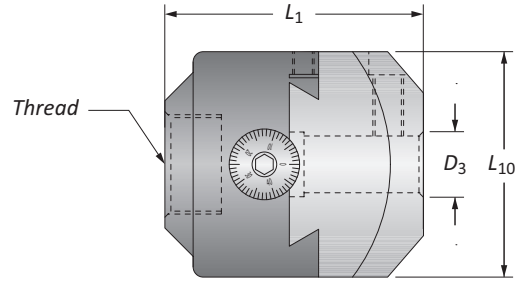

Square Style

		Boring Head					
		D_3	L_{10}	L_1	Thread	Offset	Part No.
i	0.050 - 1.625	0.500	1.50 SQ	2.250	7/8-20	0.526	SQ-1500B
	0.050 - 2.375	0.500	2.00 SQ	2.250	7/8-20	0.938	SQ-2000B
	0.500 - 4.250	0.750	3.00 SQ	2.937	1-1/2-18	1.500	SQ-3000D
	0.500 - 4.250	1.000	3.00 SQ	2.937	1-1/2-18	1.500	SQ-3000E

Imperial (in) = 0.001" adjustment on diameter

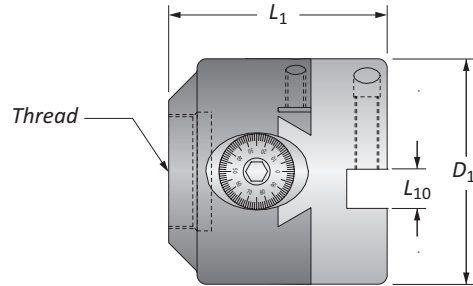

Slotted Style

		Boring Head					
		D_1	L_{10}	L_1	Thread	Offset	Part No.
i	2.00	0.375	2.406	7/8-20	0.625	CSL-202	
	3.00	0.500	2.875	1-1/2-18	1.000	CSL-203	
	4.00	0.750	3.375	1-1/2-18	1.625	CSL-204	

Imperial (in) = 0.001" adjustment on diameter

B20: 80 - 81 B20: 42 - 46 B20: 24 - 25 B20: 47 - 59 B20: 60 - 67 B20: 83

Key on B20: 1

i = Imperial (in)
m = Metric (mm)



CB Style Boring Head Replacement Parts

Square Style | Slotted Style

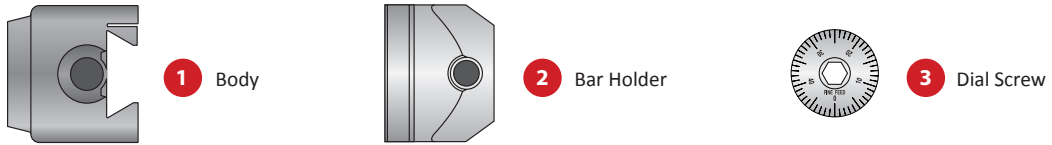

Square Style

	Head Part No.	Hardware Kit	Components		
			1	2	3
i	SQ-1500B	S1500-HDW	S1500-BD	S1500B-BH	DS-CB2
	SQ-2000B	S2000-HDW	S2000-BD	S2000B-BH	DS-CT3000
	SQ-3000D	S3000-HDW	S3000-BD	S3000D-BH	DS-CB4
	SQ-3000E	S3000-HDW	S3000-BD	S3000E-BH	DS-CB4

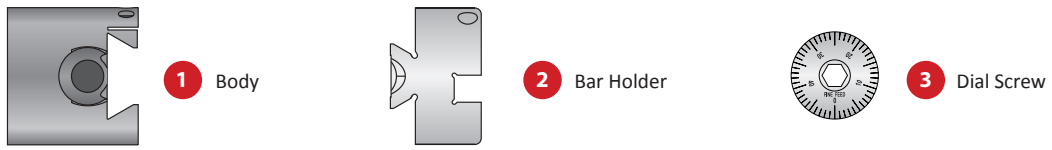

Slotted Style

	Head Part No.	Hardware Kit	Components		
			1	2	3
i	CSL-202	CB2000-HDW	CB2000-BD	SL202-BH	DS-CB2
	CSL-203	CB3000-HDW	CB3000-BD	SL203-BH	DS-CB3
	CSL-204	CB4000-HDW	CB4000-BD	SL204-BH	DS-CB4

i = Imperial (in)
m = Metric (mm)

Boring and Facing Heads

CNC Style | Manual Style | Bore Diameter Range: 0.050" - 10.625" (10.0mm - 288.0mm)

Standard feed: 0.003" per revolution
Fine feed: 0.0015" per revolution

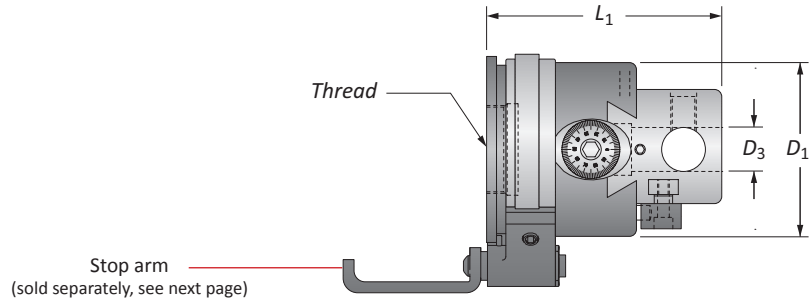

CNC Style

	Bore Diameter			Boring Head					Feed	Part No.
	Center Hole	Outboard Hole	Cross Hole*	D ₁	D ₃	L ₁	Thread	Offset		
i	0.050 - 2.875	2.375 - 4.750	4.937 - 10.625	3.000	0.750	3.875	1-1/2-18	0.812	Standard	BFC-300D
	0.050 - 2.875	2.375 - 4.750	4.937 - 10.625	3.000	0.750	3.875	1-1/2-18	0.812	Fine	BFC-300DFF
m	10.00 - 76.00	60.00 - 120.00	125.00 - 288.00	76.00	20.00	98.00	1-1/2-18	22.00	Standard	BFC-076MD
	10.00 - 76.00	60.00 - 120.00	125.00 - 288.00	76.00	20.00	98.00	1-1/2-18	22.00	Fine	BFC-076MDFF

***NOTICE:** Cross hole bars should always be secured in the bar holder with at least two set screws
 See stop arm options on following page
 See Boring and Facing boring bar option on following page
 Imperial (in) = 0.001" adjustment on diameter
 Metric (mm) = 0.02mm adjustment on diameter

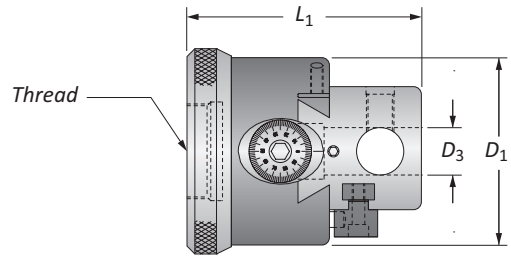

Standard feed: 0.08mm per revolution
Fine feed: 0.04mm per revolution

Manual Style

	Bore Diameter			Boring Head					Feed	Part No.
	Center Hole	Outboard Hole	Cross Hole*	D ₁	D ₃	L ₁	Thread	Offset		
i	0.050 - 2.875	2.375 - 4.750	4.937 - 10.625	3.000	0.750	3.875	1-1/2-18	0.812	Standard	BFM-300D
	0.050 - 2.875	2.375 - 4.750	4.937 - 10.625	3.000	0.750	3.875	1-1/2-18	0.812	Fine	BFM-300DFF
m	10.00 - 76.00	60.00 - 120.00	125.00 - 288.00	76.00	20.00	98.00	1-1/2-18	22.00	Standard	BFM-076MD
	10.00 - 76.00	60.00 - 120.00	125.00 - 288.00	76.00	20.00	98.00	1-1/2-18	22.00	Fine	BFM-076MDFF

***NOTICE:** Cross hole bars should always be secured in the bar holder with at least two set screws
 See Boring and Facing boring bar option on following page
 Imperial (in) = 0.001" adjustment on diameter
 Metric (mm) = 0.02mm adjustment on diameter

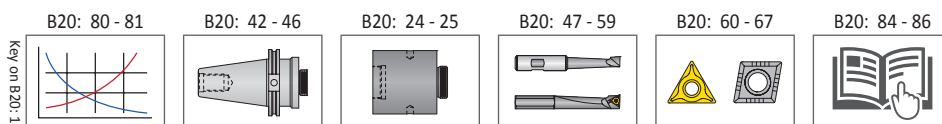

i = Imperial (in)
 m = Metric (mm)

A DRILLING
 B BORING
 C REAMING
 D BURNISHING
 E THREADING
 X SPECIALS



Boring and Facing Heads

CNC Style | Stop Arms

Stop Arms

Machine	Stop Arm Type	Part No.
-	Blank	BFC-300DSAB
Fadal	V-40	BFC-300DSAFV40
Fadal	BT-40	BFC-300DSAFBT40
HAAS	V-40	BFC-300DSAHV40
HAAS	BT-40	BFC-300DSAHBT40

Blank

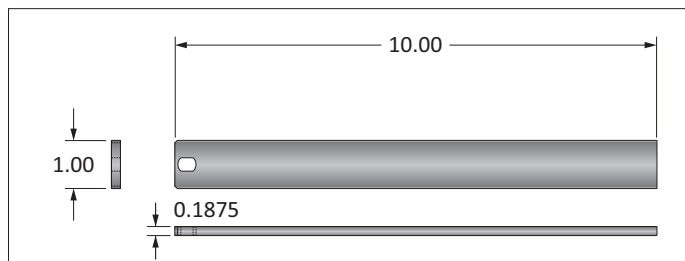

Fadal V-40

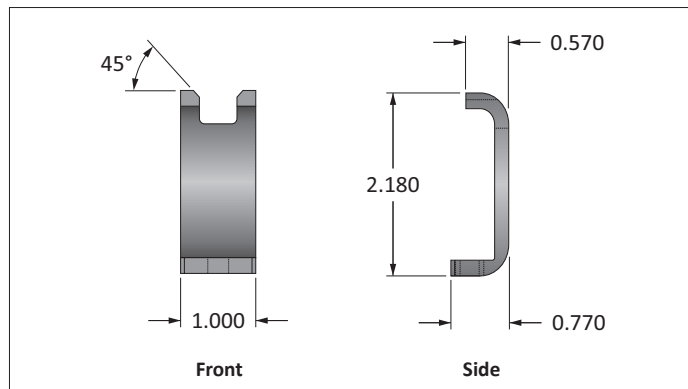

Fadal BT-40

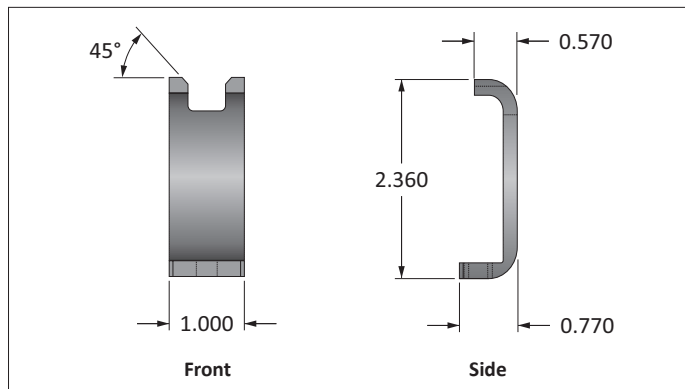

HAAS V-40

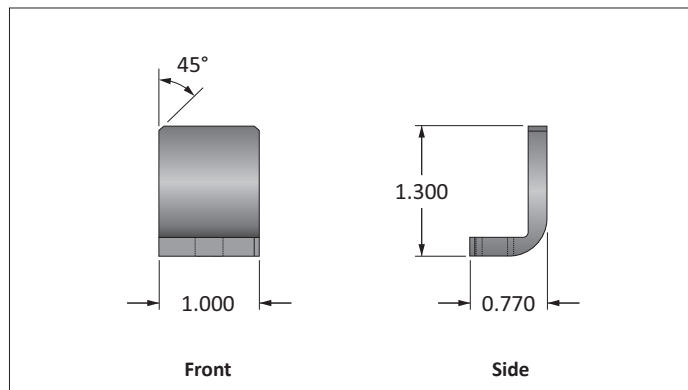

HAAS BT-40

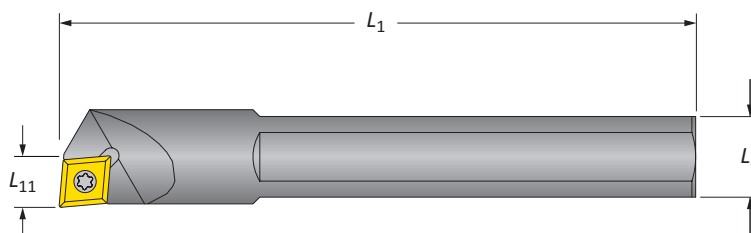
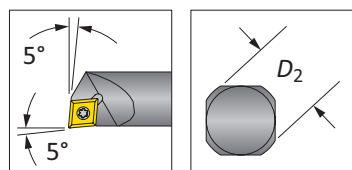
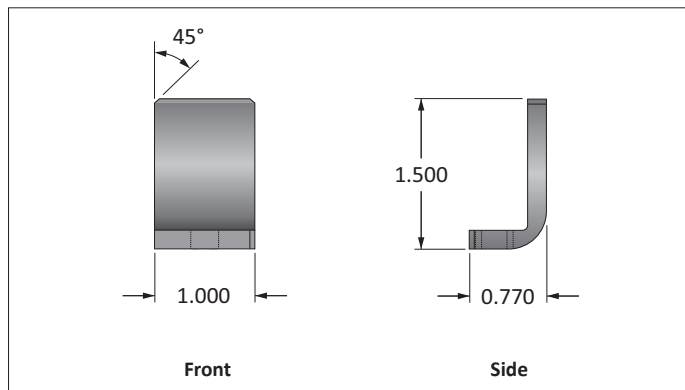

Boring and Facing Boring Bar

Boring Bar				Part No.	Insert		
L_{11}	L_1	L_8	D_2		IC	T_1	Style
i 0.406	5.00	0.640	0.750Ø	BFB-075D	0.375	0.156	◇ CP or CC

i = Imperial (in)

m = Metric (mm)

Inserts sold separately

Tiny Mite Boring Heads

002 and 152 Style | TMT Style | Bore Diameter Range: 0.050" - 1.625"

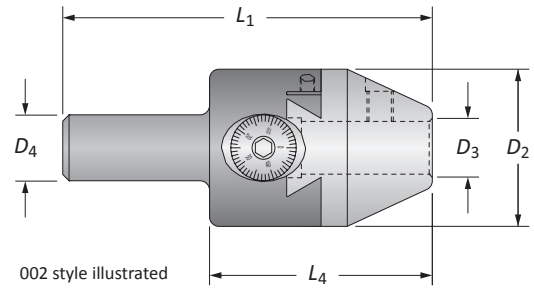

002 and 152 Style

Bore Diameter Range		Boring Head						Part No.
Center Hole	Outboard Hole	D ₂	D ₃	D ₄	L ₄	L ₁	Offset	
0.050 - 1.625	–	1.50	0.500	0.500	2.125	3.500	0.562	MB002-500
0.050 - 1.625	–	1.50	0.500	0.625	2.125	3.500	0.562	MB002-625
0.050 - 1.625	–	1.50	0.500	0.750	2.125	3.500	0.562	MB002-750
0.050 - 1.625	1.000 - 2.500	1.50	0.375	0.500	2.125	3.500	0.562	MB152-500
0.050 - 1.625	1.000 - 2.500	1.50	0.375	0.625	2.125	3.500	0.562	MB152-625
0.050 - 1.625	1.000 - 2.500	1.50	0.375	0.750	2.125	3.500	0.562	MB152-750

Imperial (in) = 0.001" adjustment on diameter

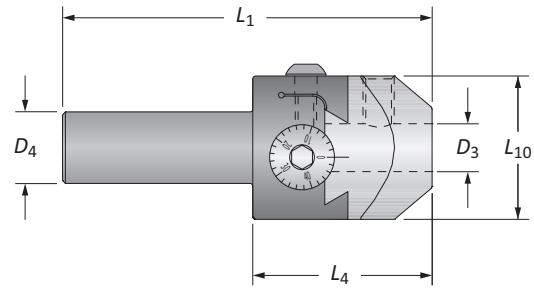

TMT Style

Bore Diameter Range		Boring Head					Part No.
Center Hole	Outboard Hole	D ₃	L ₁₀	L ₄	L ₁	D ₄	
0.050 - 0.580	–	0.250Ø	0.750	1.00	2.00	0.375	TMT-0750H
0.050 - 1.100	0.670 - 1.730	0.250Ø	1.000	1.00	2.00	0.500	TMT-1000H

Imperial (in) = 0.001" adjustment on diameter

key on B20: 1

B20: 80 - 81

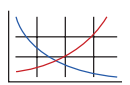

B20: 47 - 59

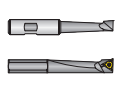

B20: 60 - 67

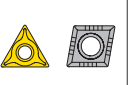

B20: 83



i = Imperial (in)
m = Metric (mm)



Tiny Mite Boring Head Replacement Parts

002 and 152 Style | TMT Style

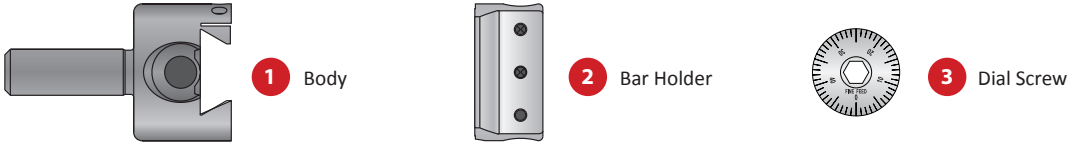

002 and 152 Style

	Head Part No.	Hardware Kit	Components		
			1	2	3
i	MB002-500	CB1500-HDW	MB002-500-BD	MB002-BH	DS-CB2
	MB002-625	CB1500-HDW	MB002-625-BD	MB002-BH	DS-CB2
	MB002-750	CB1500-HDW	MB002-750-BD	MB002-BH	DS-CB2
	MB152-500	CB1500-HDW	MB002-500-BD	MB152-BH	DS-CB2
	MB152-625	CB1500-HDW	MB002-625-BD	MB152-BH	DS-CB2
	MN152-750	CB1500-HDW	MB002-750-BD	MB152-BH	DS-CB2

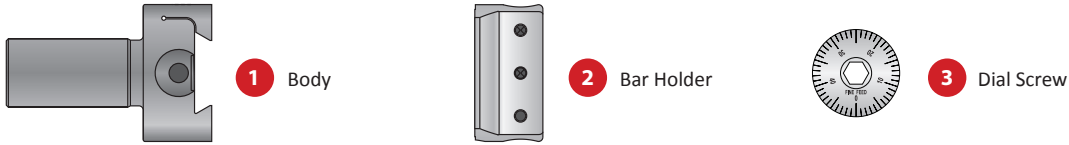

TMT Style

	Head Part No.	Hardware Kit	Components		
			1	2	3
i	TMT-0750H	TMT0750-HDW	TMT0750-BD	TMT0750H-BH	DS-MDB0750
	TMT-1000H	TMT0750-HDW	TMT1000-BD	TMT1000H-BH	DS-CT1250

i = Imperial (in)
m = Metric (mm)

Criterion Boring Head Adapters

Extensions | Reducers

Extensions

Dimensions				Part No.	Pin Spanner Wrench
D_1	L_1	Thread			
1.00	1.00	7/8-20		CB1000-IA1000	CB1000-PSW
1.00	2.00	7/8-20		CB1000-IA2000	CB1000-PSW
1.25	1.25	7/8-20		CB1250-IA1250	CB1250-PSW
1.25	2.50	7/8-20		CB1250-IA2500	CB1250-PSW
1.50	1.50	7/8-20		CB1500-IA1500	CB1500-PSW
1.50	3.00	7/8-20		CB1500-IA3000	CB1500-PSW
2.00	2.00	7/8-20		CB2000-IA2000	CB2000-PSW
2.00	4.00	7/8-20		CB2000-IA4000	CB2000-PSW
3.00	3.00	1-1/2-18		CB3000-IA3000	CB3000-PSW
3.00	6.00	1-1/2-18		CB3000-IA6000	CB3000-PSW

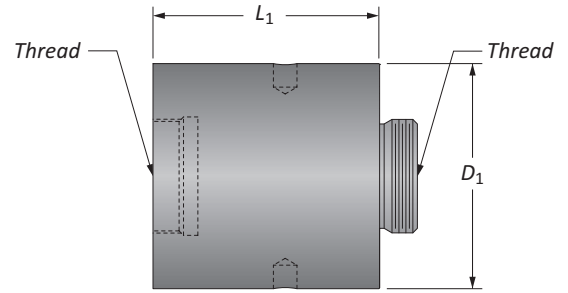

Reducers

Dimensions				Part No.	Pin Spanner Wrench
D_1	D_5	L_1	Thread		
1.50	1.00	1.00	7/8-20	CB1500-IRCB1000	CB1500-PSW
1.50	1.25	1.00	7/8-20	CB1500-IRCB1250	CB1500-PSW
2.00	1.00	1.00	7/8-20	CB2000-IRCB1000	CB2000-PSW
2.00	1.25	1.00	7/8-20	CB2000-IRCB1250	CB2000-PSW
2.00	1.50	1.00	7/8-20	CB2000-IRCB1500	CB2000-PSW
3.00	1.00	1.25	1-1/2-18	CB3000-IRCB1000	CB3000-PSW
3.00	1.25	1.25	1-1/2-18	CB3000-IRCB1250	CB3000-PSW
3.00	1.50	1.25	1-1/2-18	CB3000-IRCB1500	CB3000-PSW
3.00	2.00	1.25	1-1/2-18	CB3000-IRCB2000	CB3000-PSW

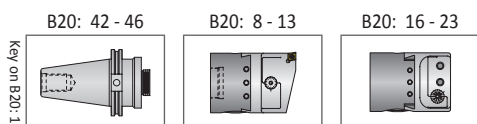
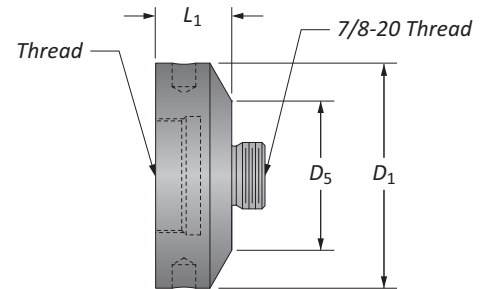

i = Imperial (in)
m = Metric (mm)



CB Style Boring Heads

Bar Holder Adapters

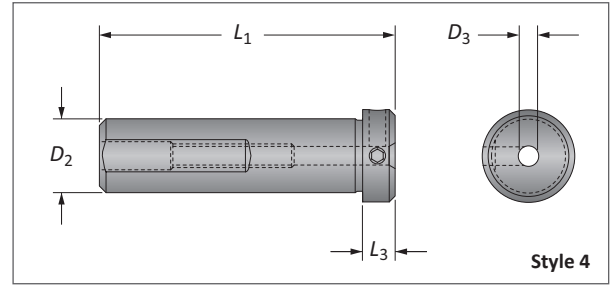
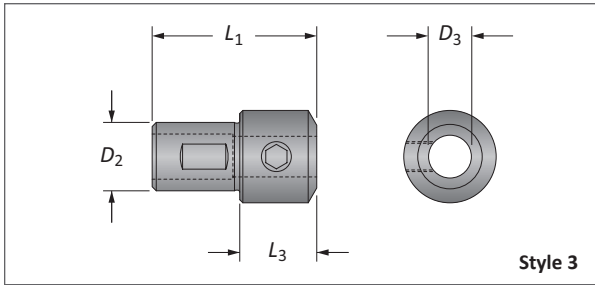
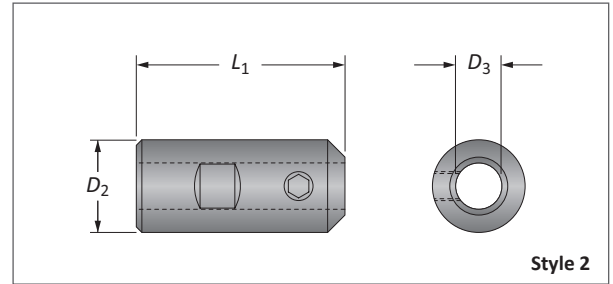
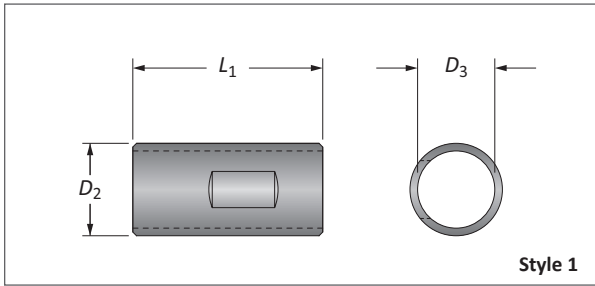

Adapter						
D_3	D_2	L_1	L_3	Style	Part No.	
0.125	0.250	0.695	0.200	3	BTH-01250250	
0.125	0.375	2.000	0.220	4	BTH-01250375	
0.125	0.500	2.000	0.220	4	BTH-01250500	
0.125	0.625	2.000	0.220	4	BTH-01250625	
0.125	0.750	2.000	0.220	4	BTH-01250750	
0.187	0.375	1.312	-	1	BTH-01870375	
0.187	0.500	1.312	-	1	BTH-01870500	
0.250	0.375	1.312	-	1	BTH-02500375	
0.250	0.500	1.312	-	1	BTH-02500500	
0.250	0.625	2.000	0.220	4	BTH-02500625	
0.250	0.750	2.000	0.220	4	BTH-02500750	
0.312	0.375	1.312	-	1	BTH-03120375	
0.312	0.500	1.312	-	1	BTH-03120500	
0.375	0.750	2.406	-	2	BTH-03750750	
0.375	1.000	2.250	-	2	BTH-03751000	
0.500	0.750	2.406	0.910	3	BTH-05000750	
0.500	1.000	2.250	-	2	BTH-05001000	
0.625	0.750	1.500	-	1	BTH-06250750	
0.625	1.000	2.406	1.120	3	BTH-06251000	
0.750	1.000	2.406	1.120	3	BTH-07501000	
1.000	1.500	3.000	1.000	3	BTH-10001500	
i						
10	12	32	-	1	BTH-10M12M	
10	20	65	24	3	BTH-10M20M	
10	25	65	-	2	BTH-10M25M	
12	20	65	24	3	BTH-12M20M	
12	25	65	-	2	BTH-12M25M	
20	25	70	28	3	BTH-20M25M	
m						

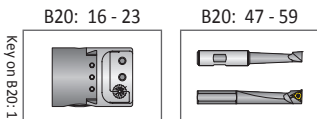

Key on B20: 1

i = Imperial (in)
m = Metric (mm)

CBER® Boring Heads

Standard Adjusting | Bore Diameter Range: 0.672" - 1.600"

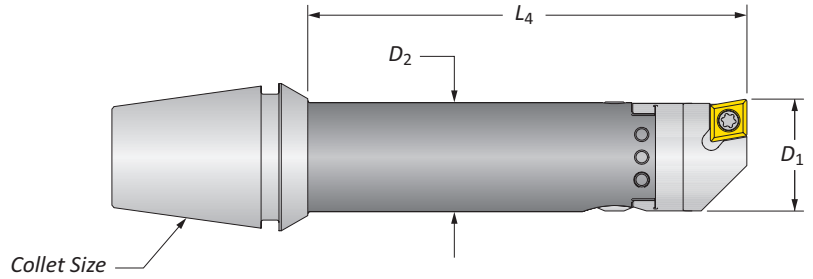

D ₁ Range	Boring Head			Part No.	Collet Nut	Collet Nut Wrench	Insert		
	D ₂	L ₄	Collet Size				IC	T ₁	Style
0.672 - 0.944	0.625	1.500	ER16	CBER16S-CP*	–	CBER16-NUTW	0.250	0.094	◇ CP or CC
0.672 - 0.944	0.625	2.500	ER16	CBER16-CP*	–	CBER16-NUTW	0.250	0.094	◇ CP or CC
0.672 - 0.944	0.625	1.500	ER16	CBER16S-TP*	–	CBER16-NUTW	0.250	0.094	△ TP
0.672 - 0.944	0.625	2.500	ER16	CBER16-TP*	–	CBER16-NUTW	0.250	0.094	△ TP
0.672 - 0.944	0.625	1.500	ER20	CBER20S-CP	CBER20-NUT	CBER20-NUTW	0.250	0.094	◇ CP or CC
0.672 - 0.944	0.625	2.500	ER20	CBER20-CP	CBER20-NUT	CBER20-NUTW	0.250	0.094	◇ CP or CC
0.672 - 0.944	0.625	1.500	ER20	CBER20S-TP	CBER20-NUT	CBER20-NUTW	0.250	0.094	△ TP
0.672 - 0.944	0.625	2.500	ER20	CBER20-TP	CBER20-NUT	CBER20-NUTW	0.250	0.094	△ TP
0.825 - 1.087	0.750	1.500	ER25	CBER25S-CP	CBER25-NUT	CBER25-NUTW	0.250	0.094	◇ CP or CC
0.825 - 1.087	0.750	3.000	ER25	CBER25-CP	CBER25-NUT	CBER25-NUTW	0.250	0.094	◇ CP or CC
0.825 - 1.087	0.750	1.500	ER25	CBER25S-TP	CBER25-NUT	CBER25-NUTW	0.250	0.094	△ TP
0.825 - 1.087	0.750	3.000	ER25	CBER25-TP	CBER25-NUT	CBER25-NUTW	0.250	0.094	△ TP
1.050 - 1.320	1.000	2.000	ER32	CBER32S-CP	CBER32-NUT	CBER32-NUTW	0.250	0.094	◇ CP or CC
1.050 - 1.320	1.000	4.000	ER32	CBER32-CP	CBER32-NUT	CBER32-NUTW	0.250	0.094	◇ CP or CC
1.050 - 1.320	1.000	2.000	ER32	CBER32S-TP	CBER32-NUT	CBER32-NUTW	0.250	0.094	△ TP
1.050 - 1.320	1.000	4.000	ER32	CBER32-TP	CBER32-NUT	CBER32-NUTW	0.250	0.094	△ TP
1.300 - 1.600	1.250	2.500	ER40	CBER40S-CP	CBER40-NUT	CBER40-NUTW	0.250	0.094	◇ CP or CC
1.300 - 1.600	1.250	5.000	ER40	CBER40-CP	CBER40-NUT	CBER40-NUTW	0.250	0.094	◇ CP or CC
1.300 - 1.600	1.250	2.500	ER40	CBER40S-TP	CBER40-NUT	CBER40-NUTW	0.250	0.094	△ TP
1.300 - 1.600	1.250	5.000	ER40	CBER40-TP	CBER40-NUT	CBER40-NUTW	0.250	0.094	△ TP
17.1 - 23.9	15.9	38.1	ER16	CBER16MS-CP*	–	CBER16-NUTW	6.35	2.38	◇ CP or CC
17.1 - 23.9	15.9	63.5	ER16	CBER16M-CP*	–	CBER16-NUTW	6.35	2.38	◇ CP or CC
17.1 - 23.9	15.9	38.1	ER16	CBER16MS-TP*	–	CBER16-NUTW	6.35	2.38	△ TP
17.1 - 23.9	15.9	63.5	ER16	CBER16M-TP*	–	CBER16-NUTW	6.35	2.38	△ TP
17.1 - 23.9	15.9	38.1	ER20	CBER20MS-CP	CBER20-NUT	CBER20-NUTW	6.35	2.38	◇ CP or CC
17.1 - 23.9	15.9	63.5	ER20	CBER20M-CP	CBER20-NUT	CBER20-NUTW	6.35	2.38	◇ CP or CC
17.1 - 23.9	15.9	38.1	ER20	CBER20MS-TP	CBER20-NUT	CBER20-NUTW	6.35	2.38	△ TP
17.1 - 23.9	15.9	63.5	ER20	CBER20M-TP	CBER20-NUT	CBER20-NUTW	6.35	2.38	△ TP
20.1 - 27.6	19.05	38.1	ER25	CBER25MS-CP	CBER25-NUT	CBER25-NUTW	6.35	2.38	◇ CP or CC
20.1 - 27.6	19.05	76.2	ER25	CBER25M-CP	CBER25-NUT	CBER25-NUTW	6.35	2.38	◇ CP or CC
20.1 - 27.6	19.05	38.1	ER25	CBER25MS-TP	CBER25-NUT	CBER25-NUTW	6.35	2.38	△ TP
20.1 - 27.6	19.05	76.2	ER25	CBER25M-TP	CBER25-NUT	CBER25-NUTW	6.35	2.38	△ TP
26.7 - 33.5	25.4	50.8	ER32	CBER32MS-CP	CBER32-NUT	CBER32-NUTW	6.35	2.38	◇ CP or CC
26.7 - 33.5	25.4	101.6	ER32	CBER32M-CP	CBER32-NUT	CBER32-NUTW	6.35	2.38	◇ CP or CC
26.7 - 33.5	25.4	50.8	ER32	CBER32MS-TP	CBER32-NUT	CBER32-NUTW	6.35	2.38	△ TP
26.7 - 33.5	25.4	101.6	ER32	CBER32M-TP	CBER32-NUT	CBER32-NUTW	6.35	2.38	△ TP
33.1 - 40.6	31.75	63.5	ER40	CBER40MS-CP	CBER40-NUT	CBER40-NUTW	6.35	2.38	◇ CP or CC
33.1 - 40.6	31.75	127	ER40	CBER40M-CP	CBER40-NUT	CBER40-NUTW	6.35	2.38	◇ CP or CC
33.1 - 40.6	31.75	63.5	ER40	CBER40MS-TP	CBER40-NUT	CBER40-NUTW	6.35	2.38	△ TP
33.1 - 40.6	31.75	127	ER40	CBER40M-TP	CBER40-NUT	CBER40-NUTW	6.35	2.38	△ TP

*NOTE: CBER16 style boring system includes the ER16 collet nut with M22x1.5 thread as part of the assembly
 Imperial (in) = 0.001" adjustment on diameter
 Metric (mm) = 0.02mm adjustment on diameter



i = Imperial (in)
 m = Metric (mm)

Inserts sold separately

CBER® Replacement Parts

Standard Adjusting



1 Body

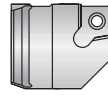

2 Insert Holder



3 Dial Screw

Head Part No.	Hardware Kit	Components			Torx Screw	Torx Wrench
		1	2	3		
CBER16S-CP	CB0625-HDW	CBER16S-BD	CB0625CP-IH	DS-MDB0625	TXS-116-1	8T-7
CBER16-CP	CB0625-HDW	CBER16BD	CB0625CP-IH	DS-MDB0625	TXS-116-1	8T-7
CBER16S-TP	CB0625-HDW	CBER16S-BD	CB0625TP-IH	DS-MDB0625	TXS-116-1	8T-7
CBER16-TP	CB0625-HDW	CBER16BD	CB0625TP-IH	DS-MDB0625	TXS-116-1	8T-7
CBER20S-CP	CB0625-HDW	CBER20S-BD	CB0625CP-IH	DS-MDB0625	TXS-116-1	8T-7
CBER20-CP	CB0625-HDW	CBER20BD	CB0625CP-IH	DS-MDB0625	TXS-116-1	8T-7
CBER20S-TP	CB0625-HDW	CBER20S-BD	CB0625TP-IH	DS-MDB0625	TXS-116-1	8T-7
CBER20-TP	CB0625-HDW	CBER20BD	CB0625TP-IH	DS-MDB0625	TXS-116-1	8T-7
CBER25S-CP	CB0750-HDW	CBER25S-BD	CB0750CP-IH	DS-MDB0750	TXS-116-1	8T-7
CBER25-CP	CB0750-HDW	CBER25BD	CB0750CP-IH	DS-MDB0750	TXS-116-1	8T-7
CBER25S-TP	CB0750-HDW	CBER25S-BD	CB0750TP-IH	DS-MDB0750	TXS-116-1	8T-7
CBER25-TP	CB0750-HDW	CBER25BD	CB0750TP-IH	DS-MDB0750	TXS-116-1	8T-7
CBER32S-CP	CB1000-HDW	CBER32S-BD	CB1000CP-IH	DS-MDB1000	TXS-116-1	8T-7
CBER32-CP	CB1000-HDW	CBER32BD	CB1000CP-IH	DS-MDB1000	TXS-116-1	8T-7
CBER32S-TP	CB1000-HDW	CBER32S-BD	CB1000TP-IH	DS-MDB1000	TXS-116-1	8T-7
CBER32-TP	CB1000-HDW	CBER32BD	CB1000TP-IH	DS-MDB1000	TXS-116-1	8T-7
CBER40S-CP	CB1250-HDW	CBER40S-BD	CB1250CP-IH	DS-MDB1000	TXS-116-1	8T-7
CBER40-CP	CB1250-HDW	CBER40BD	CB1250CP-IH	DS-MDB1000	TXS-116-1	8T-7
CBER40S-TP	CB1250-HDW	CBER40S-BD	CB1250TP-IH	DS-MDB1000	TXS-116-1	8T-7
CBER40-TP	CB1250-HDW	CBER40BD	CB1250TP-IH	DS-MDB1000	TXS-116-1	8T-7
CBER16MS-CP	CB0625-HDW	CBER16MS-BD	CB016MCP-IH	DS-MDB16M	TXS-116-1	8T-7
CBER16M-CP	CB0625-HDW	CBER16M-BD	CB016MCP-IH	DS-MDB16M	TXS-116-1	8T-7
CBER16MS-TP	CB0625-HDW	CBER16MS-BD	CB016MTP-IH	DS-MDB16M	TXS-116-1	8T-7
CBER16M-TP	CB0625-HDW	CBER16M-BD	CB016MTP-IH	DS-MDB16M	TXS-116-1	8T-7
CBER20MS-CP	CB0625-HDW	CBER20MS-BD	CB016MCP-IH	DS-MDB16M	TXS-116-1	8T-7
CBER20M-CP	CB0625-HDW	CBER20M-BD	CB016MCP-IH	DS-MDB16M	TXS-116-1	8T-7
CBER20MS-TP	CB0625-HDW	CBER20MS-BD	CB016MTP-IH	DS-MDB16M	TXS-116-1	8T-7
CBER20M-TP	CB0625-HDW	CBER20M-BD	CB016MTP-IH	DS-MDB16M	TXS-116-1	8T-7
CBER25MS-CP	CB0750-HDW	CBER25MS-BD	CB020MCP-IH	DS-MDB20M	TXS-116-1	8T-7
CBER25M-CP	CB0750-HDW	CBER25M-BD	CB020MCP-IH	DS-MDB20M	TXS-116-1	8T-7
CBER25MS-TP	CB0750-HDW	CBER25MS-BD	CB020MTP-IH	DS-MDB20M	TXS-116-1	8T-7
CBER25M-TP	CB0750-HDW	CBER25M-BD	CB020MTP-IH	DS-MDB20M	TXS-116-1	8T-7
CBER32MS-CP	CB1000-HDW	CBER32MS-BD	CB025MCP-IH	DS-MDB25M	TXS-116-1	8T-7
CBER32M-CP	CB1000-HDW	CBER32M-BD	CB025MCP-IH	DS-MDB25M	TXS-116-1	8T-7
CBER32MS-TP	CB1000-HDW	CBER32MS-BD	CB025MTP-IH	DS-MDB25M	TXS-116-1	8T-7
CBER32M-TP	CB1000-HDW	CBER32M-BD	CB025MTP-IH	DS-MDB25M	TXS-116-1	8T-7
CBER40MS-CP	CB1250-HDW	CBER40MS-BD	CB032MCP-IH	DS-MDB25M	TXS-116-1	8T-7
CBER40M-CP	CB1250-HDW	CBER40M-BD	CB032MCP-IH	DS-MDB25M	TXS-116-1	8T-7
CBER40MS-TP	CB1250-HDW	CBER40MS-BD	CB032MTP-IH	DS-MDB25M	TXS-116-1	8T-7
CBER40M-TP	CB1250-HDW	CBER40M-BD	CB032MTP-IH	DS-MDB25M	TXS-116-1	8T-7

i = Imperial (in)

m = Metric (mm)

Screws sold in multiples of 10

CBER® Boring Heads

Micro Adjusting | SGL Style

A DRILLING

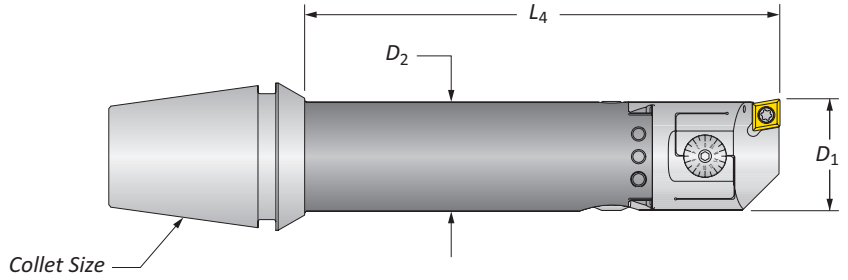

B BORING

Micro Adjusting

D ₁ Range	Boring Head			Part No.	Collet Nut	Collet Nut Wrench	Insert			
	D ₂	L ₄	Collet Size				IC	T ₁	Style	
i	1.050 - 1.320	1.000	2.700	ER32	CBER32S-CPMA	CBER32-NUT	CBER32-NUTW	0.250	0.094	◇ CP or CC
	1.050 - 1.320	1.000	4.700	ER32	CBER32-CPMA	CBER32-NUT	CBER32-NUTW	0.250	0.094	◇ CP or CC
	1.050 - 1.320	1.000	2.700	ER32	CBER32S-TPMA	CBER32-NUT	CBER32-NUTW	0.250	0.094	▲ TP
	1.050 - 1.320	1.000	4.700	ER32	CBER32-TPMA	CBER32-NUT	CBER32-NUTW	0.250	0.094	▲ TP
	1.300 - 1.600	1.250	3.200	ER40	CBER40S-CPMA	CBER40-NUT	CBER40-NUTW	0.250	0.094	◇ CP or CC
	1.300 - 1.600	1.250	5.700	ER40	CBER40-CPMA	CBER40-NUT	CBER40-NUTW	0.250	0.094	◇ CP or CC
	1.300 - 1.600	1.250	3.200	ER40	CBER40S-TPMA	CBER40-NUT	CBER40-NUTW	0.250	0.094	▲ TP
	1.300 - 1.600	1.250	5.700	ER40	CBER40-TPMA	CBER40-NUT	CBER40-NUTW	0.250	0.094	▲ TP
m	26.7 - 33.5	25.4	68.5	ER32	CBER32MS-CPMA	CBER32-NUT	CBER32-NUTW	6.35	2.38	◇ CP or CC
	26.7 - 33.5	25.4	119.4	ER32	CBER32M-CPMA	CBER32-NUT	CBER32-NUTW	6.35	2.38	◇ CP or CC
	26.7 - 33.5	25.4	68.5	ER32	CBER32MS-TPMA	CBER32-NUT	CBER32-NUTW	6.35	2.38	▲ TP
	26.7 - 33.5	25.4	119.4	ER32	CBER32M-TPMA	CBER32-NUT	CBER32-NUTW	6.35	2.38	▲ TP
	33.1 - 40.6	31.75	81.2	ER40	CBER40MS-CPMA	CBER40-NUT	CBER40-NUTW	6.35	2.38	◇ CP or CC
	33.1 - 40.6	31.75	144.7	ER40	CBER40M-CPMA	CBER40-NUT	CBER40-NUTW	6.35	2.38	◇ CP or CC
	33.1 - 40.6	31.75	81.2	ER40	CBER40MS-TPMA	CBER40-NUT	CBER40-NUTW	6.35	2.38	▲ TP
	33.1 - 40.6	31.75	144.7	ER40	CBER40M-TPMA	CBER40-NUT	CBER40-NUTW	6.35	2.38	▲ TP

Imperial (in) = 0.00005" adjustment on diameter
 Metric (mm) = 0.001mm adjustment on diameter

C REAMING

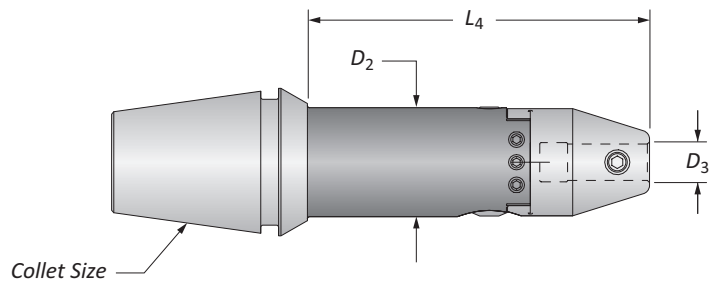

D BURNISHING

SGL Style

D ₁ Range	Boring Head			Collet Size	Part No.	Collet Nut	Collet Nut Wrench
	D ₃	D ₂	L ₄				
0.050 - 0.380	0.125	0.625	1.500	ER16	CBER16S-SG*	-	CBER16-NUTW
0.050 - 0.380	0.125	0.625	2.500	ER16	CBER16-SG*	-	CBER16-NUTW
0.050 - 0.380	0.125	0.625	1.500	ER20	CBER20S-SG	CBER20-NUT	CBER20-NUTW
0.050 - 0.380	0.125	0.625	2.500	ER20	CBER20-SG	CBER20-NUT	CBER20-NUTW
i	0.050 - 0.470	0.250	0.750	ER25	CBER25S-SH	CBER25-NUT	CBER25-NUTW
	0.050 - 0.470	0.250	3.187	ER25	CBER25-SH	CBER25-NUT	CBER25-NUTW
	0.120 - 0.645	0.375	1.000	ER32	CBER32S-SA	CBER32-NUT	CBER32-NUTW
	0.120 - 0.645	0.375	4.437	ER32	CBER32-SA	CBER32-NUT	CBER32-NUTW
	0.250 - 0.800	0.500	1.250	ER40	CBER40S-SB	CBER40-NUT	CBER40-NUTW
	0.250 - 0.800	0.500	5.281	ER40	CBER40-SB	CBER40-NUT	CBER40-NUTW

*NOTE: CBER16 style boring system includes the ER16 collet nut with M22x1.5 thread as part of the assembly
 Imperial (in) = 0.001" adjustment on diameter

F THREADING

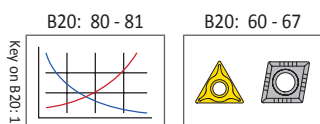

i = Imperial (in)
 m = Metric (mm)
 Inserts sold separately

X SPECIALS

CBER® Replacement Parts

Micro Adjusting | SGL Style



Micro Adjusting

	Head Part No.	Hardware Kit	Components						
			1	2	3	4			
i	CBER32S-CPMA	CB1000-HDW	CBER32S-BD	CB1000CPMA-IH	DS-MDB1000	DS-MA1500	MAW-1000	TXS-116-1	8T-7
	CBER32-CPMA	CB1000-HDW	CBER32BD	CB1000CPMA-IH	DS-MDB1000	DS-MA1500	MAW-1000	TXS-116-1	8T-7
	CBER32S-TPMA	CB1000-HDW	CBER32S-BD	CB1000TPMA-IH	DS-MDB1000	DS-MA1500	MAW-1000	TXS-116-1	8T-7
	CBER32-TPMA	CB1000-HDW	CBER32BD	CB1000TPMA-IH	DS-MDB1000	DS-MA1500	MAW-1000	TXS-116-1	8T-7
	CBER40S-CPMA	CB1250-HDW	CBER40S-BD	CB1250CPMA-IH	DS-MDB1000	DS-MA1500	MAW-1000	TXS-116-1	8T-7
	CBER40-CPMA	CB1250-HDW	CBER40S-BD	CB1250CPMA-IH	DS-MDB1000	DS-MA1500	MAW-1000	TXS-116-1	8T-7
	CBER40S-TPMA	CB1250-HDW	CBER40S-BD	CB1250TPMA-IH	DS-MDB1000	DS-MA1500	MAW-1000	TXS-116-1	8T-7
	CBER40-TPMA	CB1250-HDW	CBER40BD	CB1250TPMA-IH	DS-MDB1000	DS-MA1500	MAW-1000	TXS-116-1	8T-7
m	CBER32MS-CPMA	CB1000-HDW	CBER32MS-BD	CB025MCPMA-IH	DS-MDB25M	DS-MA1500	MAW-1000	TXS-116-1	8T-7
	CBER32M-CPMA	CB1000-HDW	CBER32M-BD	CB025MCPMA-IH	DS-MDB25M	DS-MA1500	MAW-1000	TXS-116-1	8T-7
	CBER32MS-TPMA	CB1000-HDW	CBER32MS-BD	CB025MTPMA-IH	DS-MDB25M	DS-MA1500	MAW-1000	TXS-116-1	8T-7
	CBER32M-TPMA	CB1000-HDW	CBER32M-BD	CB025MTPMA-IH	DS-MDB25M	DS-MA1500	MAW-1000	TXS-116-1	8T-7
	CBER40MS-CPMA	CB1250-HDW	CBER40MS-BD	CB032MCPMA-IH	DS-MDB25M	DS-MA1500	MAW-1000	TXS-116-1	8T-7
	CBER40M-CPMA	CB1250-HDW	CBER40M-BD	CB032MCPMA-IH	DS-MDB25M	DS-MA1500	MAW-1000	TXS-116-1	8T-7
	CBER40MS-TPMA	CB1250-HDW	CBER40MS-BD	CB032MTPMA-IH	DS-MDB25M	DS-MA1500	MAW-1000	TXS-116-1	8T-7
	CBER40M-TPMA	CB1250-HDW	CBER40M-BD	CB032MTPMA-IH	DS-MDB25M	DS-MA1500	MAW-1000	TXS-116-1	8T-7

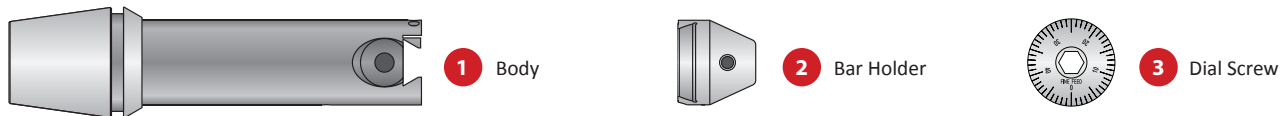

SGL Style

	Head Part No.	Hardware Kit	Components		
			1	2	3
i	CBER16S-SG	CB0625-HDW	CBER16S-BD	SGL0625G-BH	DS-MDB0625
	CBER16-SG	CB0625-HDW	CBER16BD	SGL0625G-BH	DS-MDB0625
	CBER20S-SG	CB0625-HDW	CBER20S-BD	SGL0625G-BH	DS-MDB0625
	CBER20-SG	CB0625-HDW	CBER20BD	SGL0625G-BH	DS-MDB0625
	CBER25S-SH	CB0750-HDW	CBER25S-BD	SGL0750H-BH	DS-MDB0750
	CBER25-SH	CB0750-HDW	CBER25BD	SGL0750H-BH	DS-MDB0750
	CBER32S-SA	CB1000-HDW	CBER32S-BD	SGL1000A-BH	DS-MDB1000
	CBER32-SA	CB1000-HDW	CBER32BD	SGL1000A-BH	DS-MDB1000
	CBER40S-SB	CB1250-HDW	CBER40S-BD	SGL1250B-BH	DS-MDB1000
	CBER40-SB	CB1250-HDW	CBER40BD	SGL1250B-BH	DS-MDB1000

i = Imperial (in)

m = Metric (mm)

Screws sold in multiples of 10

Cri-Tip Boring Heads - Komet® ABS® Connection

Standard Adjusting | Bore Diameter Range: 1.585" - 5.065" (38mm - 76mm)

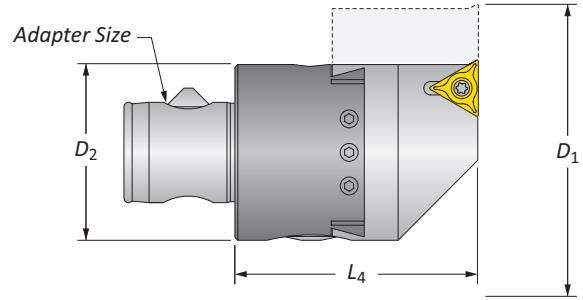

<i>D</i> ₁ Range	Boring Head			Part No.	IC	Insert		
	<i>D</i> ₂	<i>L</i> ₄	Adapter Size			<i>T</i> ₁	Style	
i	1.585 - 2.700	1.500	2.550	A40	CTP1500-A40TP	0.375	0.125	▲ TP
	1.585 - 2.700	1.500	2.550	A40	CTP1500-A40CP	0.375	0.156	◆ CP or CC
	1.585 - 2.700	1.500	2.800*	A50	CTP1500-A50TP	0.375	0.125	▲ TP
	1.585 - 2.700	1.500	2.800*	A50	CTP1500-A50CP	0.375	0.156	◆ CP or CC
	2.060 - 3.320	2.000	2.925	A50	CTP2000-A50TP	0.375	0.125	▲ TP
	2.060 - 3.320	2.000	2.925	A50	CTP2000-A50CP	0.375	0.156	◆ CP or CC
	3.065 - 5.065	3.000	4.250	A80	CTP3000-A80TP	0.375	0.125	▲ TP
	3.065 - 5.065	3.000	4.250	A80	CTP3000-A80CP	0.375	0.156	◆ CP or CC
m	41.00 - 68.00	38.00	64.00	A40	CTP038M-A40TP	9.53	3.18	▲ TP
	41.00 - 68.00	38.00	64.00	A40	CTP038M-A40CP	9.53	3.96	◆ CP or CC
	41.00 - 68.00	38.00	71.00*	A50	CTP038M-A50TP	9.53	3.18	▲ TP
	41.00 - 68.00	38.00	71.00*	A50	CTP038M-A50CP	9.53	3.96	◆ CP or CC
	53.00 - 84.00	50.00	74.00	A50	CTP050M-A50TP	9.53	3.18	▲ TP
	53.00 - 84.00	50.00	74.00	A50	CTP050M-A50CP	9.53	3.96	◆ CP or CC
	78.00 - 128.00	76.00	100.00	A80	CTP076M-A80TP	9.53	3.18	▲ TP
	78.00 - 128.00	76.00	100.00	A80	CTP076M-A80CP	9.53	3.96	◆ CP or CC

*Max bore depth is 2.087" (53mm)
 Imperial (in) = 0.001" adjustment on diameter
 Metric (mm) = 0.02mm adjustment on diameter

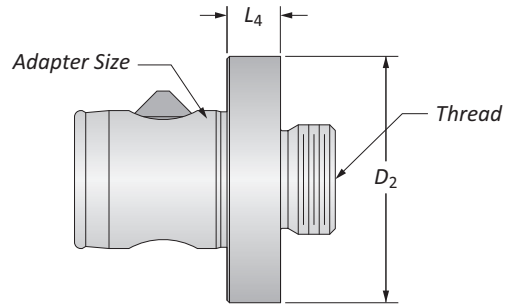

Shanks

<i>i</i>	Shank				Part No.
	<i>D</i> ₂	<i>L</i> ₄	Thread	Adapter Size	
i	1.500	0.430	7/8-20	A40	CTP1500-A400875
	2.000	0.430	7/8-20	A50	CTP2000-A500875
	3.000	1.050	1-1/2-18	A80	CTP3000-A801500

B20: 80 - 81 B20: 60 - 67 B20: 71

i = Imperial (in)
m = Metric (mm)
 Inserts sold separately



Cri-Tip Boring Heads - Komet® ABS® Connection

Micro Adjusting | Bore Diameter Range: 1.585" - 5.065" (38mm - 76mm)

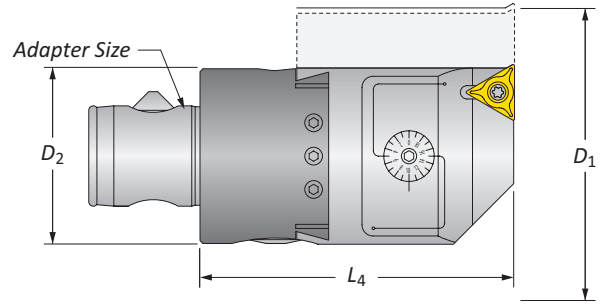

	Boring Head				Part No.	Insert		
	D ₁ Range	D ₂	L ₄	Adapter Size		IC	T ₁	Style
i	1.585 - 2.700	1.500	3.250	A40	CTP1500-A40TPMA	0.375	0.125	▲ TP
	1.585 - 2.700	1.500	3.250	A40	CTP1500-A40CPMA	0.375	0.156	◆ CP or CC
	1.585 - 2.700	1.500	3.500*	A50	CTP1500-A50TPMA	0.375	0.125	▲ TP
	1.585 - 2.700	1.500	3.500*	A50	CTP1500-A50CPMA	0.375	0.156	◆ CP or CC
	2.060 - 3.320	2.000	3.750	A50	CTP2000-A50TPMA	0.375	0.125	▲ TP
	2.060 - 3.320	2.000	3.750	A50	CTP2000-A50CPMA	0.375	0.156	◆ CP or CC
	3.065 - 5.065	3.000	4.875	A80	CTP3000-A80TPMA	0.375	0.125	▲ TP
	3.065 - 5.065	3.000	4.875	A80	CTP3000-A80CPMA	0.375	0.156	◆ CP or CC
m	41.00 - 68.00	38.00	82.00	A40	CTP038M-A40TPMA	9.53	3.18	▲ TP
	41.00 - 68.00	38.00	82.00	A40	CTP038M-A40CPMA	9.53	3.96	◆ CP or CC
	41.00 - 68.00	38.00	88.00*	A50	CTP038M-A50TPMA	9.53	3.18	▲ TP
	41.00 - 68.00	38.00	88.00*	A50	CTP038M-A50CPMA	9.53	3.96	◆ CP or CC
	53.00 - 84.00	50.00	95.00	A50	CTP050M-A50TPMA	9.53	3.18	▲ TP
	53.00 - 84.00	50.00	95.00	A50	CTP050M-A50CPMA	9.53	3.96	◆ CP or CC
	78.00 - 128.00	76.00	123.00	A80	CTP076M-A80TPMA	9.53	3.18	▲ TP
	78.00 - 128.00	76.00	123.00	A80	CTP076M-A80CPMA	9.53	3.96	◆ CP or CC

*Max bore depth is 2.087" (53mm)
 Imperial (in) = 0.00005" adjustment on diameter
 Metric (mm) = 0.001mm adjustment on diameter

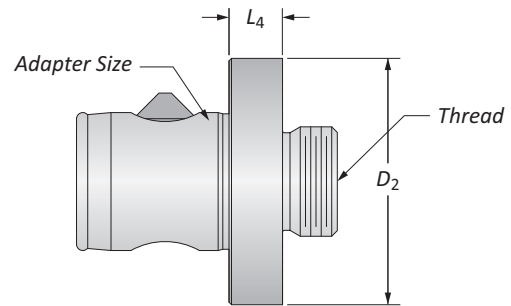

Shanks

	Shank				Part No.
	D ₂	L ₄	Thread	Adapter Size	
i	1.500	0.430	7/8-20	A40	CTP1500-A400875
	2.000	0.430	7/8-20	A50	CTP2000-A500875
	3.000	1.050	1-1/2-18	A80	CTP3000-A801500

B20: 80 - 81

B20: 60 - 67

B20: 71

i = Imperial (in)
 m = Metric (mm)
 Inserts sold separately

Cri-Tip Boring Heads - Big® Kaiser® Connection

Standard Adjusting | Bore Diameter Range: 1.585" - 5.065" (41mm - 128mm)

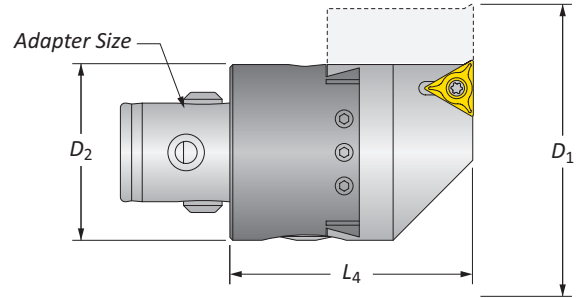

	Boring Heads				Insert			
	D_1 Range	D_4	L_4	Adapter Size	Part No.	IC	T_1	Style
i	1.585 - 2.700	1.500	2.305	KA4	CTP1500-K4TP	0.375	0.125	▲ TP
	1.585 - 2.700	1.500	2.305	KA4	CTP1500-K4CP	0.375	0.156	◆ CP or CC
	1.585 - 2.700	1.500	2.550*	KA5	CTP1500-K5TP	0.375	0.125	▲ TP
	1.585 - 2.700	1.500	2.550*	KA5	CTP1500-K5CP	0.375	0.156	◆ CP or CC
	2.060 - 3.320	2.000	2.740	KA5	CTP2000-K5TP	0.375	0.125	▲ TP
	2.060 - 3.320	2.000	2.740	KA5	CTP2000-K5CP	0.375	0.156	◆ CP or CC
	3.065 - 5.065	3.000	3.940	KA7	CTP3000-K7TP	0.375	0.125	▲ TP
	3.065 - 5.065	3.000	3.940	KA7	CTP3000-K7CP	0.375	0.156	◆ CP or CC
m	41.00 - 68.00	38.00	58.00	KA4	CTP038M-K4TP	9.53	3.18	▲ TP
	41.00 - 68.00	38.00	58.00	KA4	CTP038M-K4CP	9.53	3.96	◆ CP or CC
	41.00 - 68.00	38.00	64.00*	KA5	CTP038M-K5TP	9.53	3.18	▲ TP
	41.00 - 68.00	38.00	64.00*	KA5	CTP038M-K5CP	9.53	3.96	◆ CP or CC
	53.00 - 84.00	50.00	69.00	KA5	CTP050M-K5TP	9.53	3.18	▲ TP
	53.00 - 84.00	50.00	69.00	KA5	CTP050M-K5CP	9.53	3.96	◆ CP or CC
	78.00 - 128.00	76.00	100.00	KA7	CTP076M-K7TP	9.53	3.18	▲ TP
	78.00 - 128.00	76.00	100.00	KA7	CTP076M-K7CP	9.53	3.96	◆ CP or CC

*Max bore depth is 2.087" (53mm)
 Imperial (in) = 0.001" adjustment on diameter
 Metric (mm) = 0.02mm adjustment on diameter

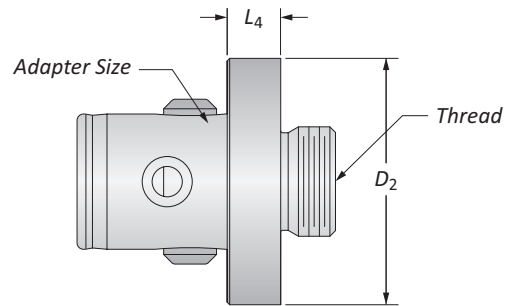

Shanks

	Shank				
	D_2	L_4	Thread	Adapter Size	Part No.
i	1.500	0.500	7/8-20	KA4	CTP1500-K408752
	2.000	0.500	7/8-20	KA5	CTP2000-K508752
	3.000	0.750	1-1/2-18	KA7	CTP3000-K715001

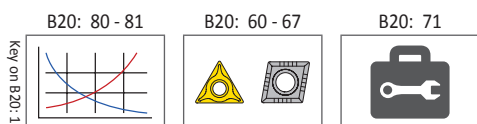

i = Imperial (in)
 m = Metric (mm)
 Inserts sold separately

A DRILLING
 B BORING
 C REAMING
 D BURNISHING
 E THREADING
 X SPECIALS



Cri-Tip Boring Heads - Big® Kaiser® Connection

Micro Adjusting | Bore Diameter Range: 1.585" - 5.065" (41mm - 128mm)

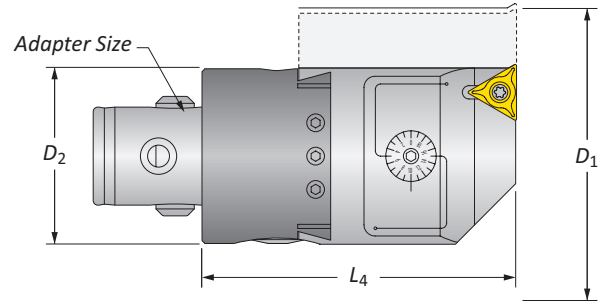

	Boring Head				Insert			
	D_1 Range	D_4	L_4	Adapter Size	Part No.	IC	T_1	Style
i	1.585 - 2.700	1.500	3.000	KA4	CTP1500-K4TPMA	0.375	0.125	▲ TP
	1.585 - 2.700	1.500	3.000	KA4	CTP1500-K4CPMA	0.375	0.156	◆ CP or CC
	1.585 - 2.700	1.500	3.250*	KA5	CTP1500-K5TPMA	0.375	0.125	▲ TP
	1.585 - 2.700	1.500	3.250*	KA5	CTP1500-K5CPMA	0.375	0.156	◆ CP or CC
	2.060 - 3.320	2.000	3.560	KA5	CTP2000-K5TPMA	0.375	0.125	▲ TP
	2.060 - 3.320	2.000	3.560	KA5	CTP2000-K5CPMA	0.375	0.156	◆ CP or CC
	3.065 - 5.065	3.000	4.560	KA7	CTP3000-K7TPMA	0.375	0.125	▲ TP
	3.065 - 5.065	3.000	4.560	KA7	CTP3000-K7CPMA	0.375	0.156	◆ CP or CC
m	41.00 - 68.00	38.00	76.00	KA4	CTP038M-K4TPMA	9.53	3.18	▲ TP
	41.00 - 68.00	38.00	76.00	KA4	CTP038M-K4CPMA	9.53	3.96	◆ CP or CC
	41.00 - 68.00	38.00	82.00*	KA5	CTP038M-K5TPMA	9.53	3.18	▲ TP
	41.00 - 68.00	38.00	82.00*	KA5	CTP038M-K5CPMA	9.53	3.96	◆ CP or CC
	53.00 - 84.00	50.00	90.00	KA5	CTP050M-K5TPMA	9.53	3.18	▲ TP
	53.00 - 84.00	50.00	90.00	KA5	CTP050M-K5CPMA	9.53	3.96	◆ CP or CC
	78.00 - 128.00	76.00	115.00	KA7	CTP076M-K7TPMA	9.53	3.18	▲ TP
	78.00 - 128.00	76.00	115.00	KA7	CTP076M-K7CPMA	9.53	3.96	◆ CP or CC

*Max bore depth is 2.087" (53mm)

Imperial (in) = 0.00005" adjustment on diameter

Metric (mm) = 0.001mm adjustment on diameter

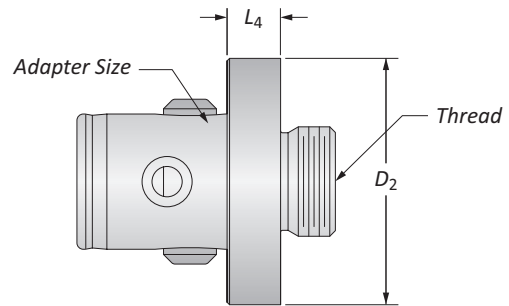

Shanks

	Shank				
	D_2	L_4	Thread	Adapter Size	Part No.
i	1.500	0.500	7/8-20	KA4	CTP1500-K408752
	2.000	0.500	7/8-20	KA5	CTP2000-K508752
	3.000	0.750	1-1/2-18	KA7	CTP3000-K715001

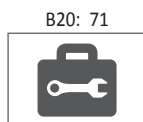
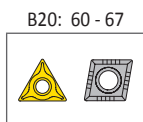
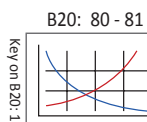

i = Imperial (in)

m = Metric (mm)

Inserts sold separately

Cri-Tip Boring Heads - Komet® ABS® Connection

CB Style Standard Adjusting | Bore Diameter Range: 0.050" - 11.000" (3mm - 279mm)

A
DRILLING

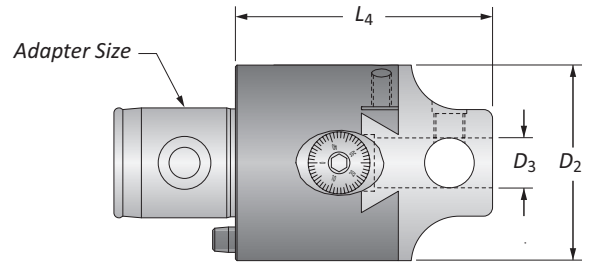

B
BORING

	Bore Diameter			Boring Head				Part No.	
	Center Hole	Outboard Hole	Cross Hole*	D_3	D_2	L_4	Offset		Adapter Size
	0.050 - 1.625	-	-	0.500	1.500	2.530	0.562	A40	CTP1500-A40002
	0.050 - 1.625	1.000 - 2.500	-	0.375	1.500	2.530	0.562	A40	CTP1500-A40152
	0.050 - 1.625	-	-	0.500	1.500	2.780	0.562	A50	CTP1500-A50002
	0.050 - 1.625	1.000 - 2.500	-	0.375	1.500	2.780	0.562	A50	CTP1500-A50152
i	0.050 - 1.750	1.312 - 3.000	2.875 - 6.687	0.375	2.000	2.600	0.625	A50	CTP2000-A50202A
	0.050 - 1.750	1.312 - 3.000	2.875 - 6.687	0.500	2.000	2.600	0.625	A50	CTP2000-A50202B
	0.050 - 3.250	2.375 - 5.125	4.937 - 11.000	0.750	3.000	3.945	1.000	A80	CTP3000-A80203D
	0.050 - 3.250	2.375 - 5.125	-	0.750	3.000	4.165	1.000	A80	CTP3000-A8030MA**
	3.00 - 40.00	-	-	12.00	38.00	64.00	14	A40	CTP038M-A40B
	3.00 - 40.00	-	-	12.00	38.00	71.00	14	A50	CTP038M-A50B
m	3.00 - 44.00	35.00 - 76.00	73.00 - 169.00	12.00	50.00	66.00	16	A50	CTP050M-A50B
	10.00 - 70.00	60.00 - 130.00	126.00 - 279.00	20.00	76.00	100.00	25	A80	CTP076M-A80B
	10.00 - 70.00	60.00 - 130.00	-	20.00	76.00	106.00	25	A80	CTP076M-A80DMA**

***NOTICE:** Cross hole bars should always be secured in the bar holder with at least two set screws
 Imperial (in) = 0.001" adjustment on diameter | **Micro = 0.00005" adjustment on diameter
 Metric (mm) = 0.02mm adjustment on diameter | **Micro = 0.001mm adjustment on diameter

C
REAMING

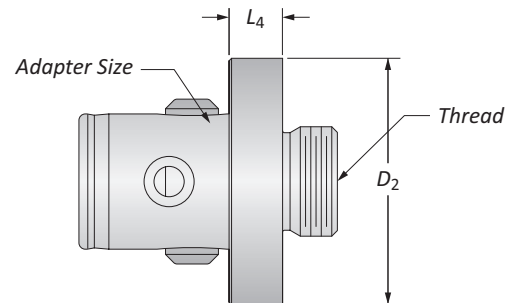

D
BURNISHING

Shanks

	Shank				Part No.
	D_2	L_4	Thread	Adapter Size	
i	1.500	0.430	7/8-20	A40	CTP1500-A400875
	2.000	0.430	7/8-20	A50	CTP2000-A500875
	3.000	1.050	1-1/2-18	A80	CTP3000-A801500

E
THREADING

X
SPECIALS

B20: 80 - 81 B20: 47 - 59 B20: 60 - 67 B20: 71

Key on B20: 1

i = Imperial (in)
m = Metric (mm)



Cri-Tip Boring Heads - Big® Kaiser® Connection

CB Style Standard Adjusting | Bore Diameter Range: 0.050" - 11.000" (3mm - 279mm)

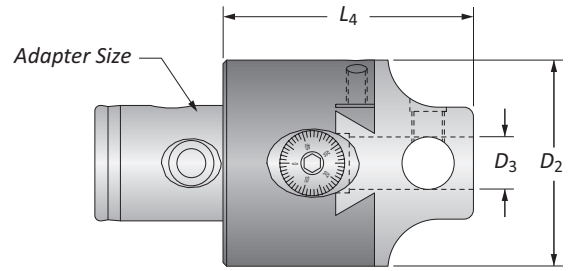

	Bore Diameter			Boring Head				Part No.	
	Center Hole	Outboard Hole	Cross Hole*	D ₃	D ₂	L ₄	Offset		Adapter Size
i	0.050 - 1.625	-	-	0.500	1.500	2.280	0.562	KA4	CTP1500-K4002
	0.050 - 1.625	1.000 - 2.500	-	0.375	1.500	2.280	0.562	KA4	CTP1500-K4152
	0.050 - 1.625	-	-	0.500	1.500	2.530	0.562	KA5	CTP1500-K5002
	0.050 - 1.625	1.000 - 2.500	-	0.375	1.500	2.530	0.562	KA5	CTP1500-K5152
	0.050 - 1.750	1.312 - 3.000	2.875 - 6.687	0.375	2.000	2.405	0.625	KA5	CTP2000-K5202A
	0.050 - 1.750	1.312 - 3.000	2.875 - 6.687	0.500	2.000	2.405	0.625	KA5	CTP2000-K5202B
	0.050 - 3.250	2.375 - 5.125	4.937 - 11.000	0.750	3.000	3.625	1.000	KA7	CTP3000-K7203D
	0.050 - 3.250	2.375 - 5.125	-	0.750	3.000	3.855	1.000	KA7	CTP3000-K7300MA**
m	3.00 - 40.00	-	-	12.00	38.00	58.00	14	KA4	CTP038M-K4B
	3.00 - 40.00	-	-	12.00	38.00	64.00	14	KA5	CTP038M-K5B
	3.00 - 44.00	35.00 - 76.00	73.00 - 169.00	12.00	50.00	61.00	16	KA5	CTP050M-K5B
	10.00 - 70.00	60.00 - 130.00	126.00 - 279.00	20.00	76.00	92.00	25	KA7	CTP076M-K7D
	10.00 - 70.00	60.00 - 130.00	-	20.00	76.00	98.00	25	KA7	CTP076M-K7DMA**

***NOTICE:** Cross hole bars should always be secured in the bar holder with at least two set screws
 Imperial (in) = 0.001" adjustment on diameter | **Micro = 0.00005" adjustment on diameter
 Metric (mm) = 0.02mm adjustment on diameter | **Micro = 0.001mm adjustment on diameter

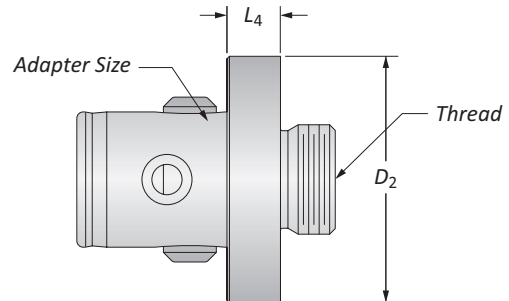

Shanks

	Shank				Part No.
	D ₂	L ₄	Thread	Adapter Size	
i	1.500	0.500	7/8-20	KA4	CTP1500-K408752
	2.000	0.500	7/8-20	KA5	CTP2000-K508752
	3.000	0.750	1-1/2-18	KA7	CTP3000-K715001

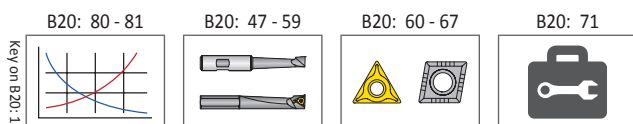

i = Imperial (in)
 m = Metric (mm)

Cri-Bar Adjustable Boring Bars

Round Shank | Bore Diameter Range: 0.050" - 1.600"

A
DRILLING

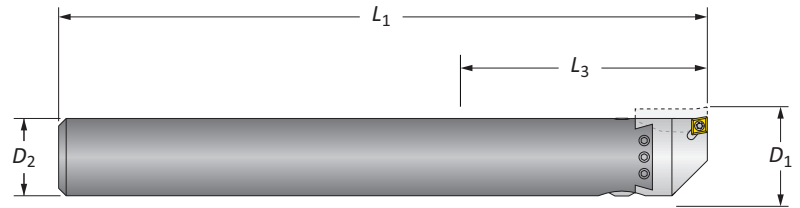

Standard Adjusting

D ₁ Range	Boring Bar			Part No.	IC	T ₁	Style
	L ₁	L ₃	D ₂				
0.672 - 0.944	5.25	3.000	0.625	CBR-0625CP*	0.250	0.094	◇ CP or CC
0.672 - 0.944	5.25	3.000	0.625	CBR-0625TP	0.250	0.094	▲ TP
0.825 - 1.087	6.31	4.000	0.750	CBR-0750CP	0.250	0.094	◇ CP or CC
0.825 - 1.087	6.31	4.000	0.750	CBR-0750TP	0.250	0.094	▲ TP
1.050 - 1.320	8.25	5.000	1.000	CBR-1000CP	0.250	0.094	◇ CP or CC
1.050 - 1.320	8.25	5.000	1.000	CBR-1000TP	0.250	0.094	▲ TP
1.300 - 1.600	10.31	6.500	1.250	CBR-1250CP	0.250	0.094	◇ CP or CC
1.300 - 1.600	10.31	6.500	1.250	CBR-1250TP	0.250	0.094	▲ TP

*CBR-0625 style boring system has a minimum bore diameter of 0.750" when using a CC style insert
Imperial (in) = 0.001" adjustment on diameter

C
REAMING

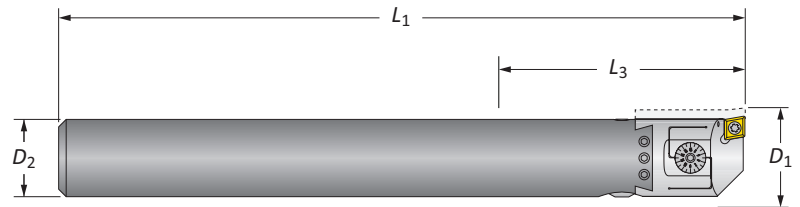

Micro Adjusting

D ₁ Range	Boring Bar			Part No.	IC	T ₁	Style
	L ₁	L ₃	D ₂				
1.050 - 1.320	8.95	3.000	1.000	CBR-1000CPMA	0.250	0.094	◇ CP or CC
1.050 - 1.320	8.95	4.000	1.000	CBR-1000TPMA	0.250	0.094	▲ TP
1.300 - 1.600	11.00	5.000	1.250	CBR-1250CPMA	0.250	0.094	◇ CP or CC
1.300 - 1.600	11.00	6.500	1.250	CBR-1250TPMA	0.250	0.094	▲ TP

The total range of the micro adjustment is 0.006" (0.150mm) on diameter
Imperial (in) = 0.00005" adjustment on diameter

D
URNISHING

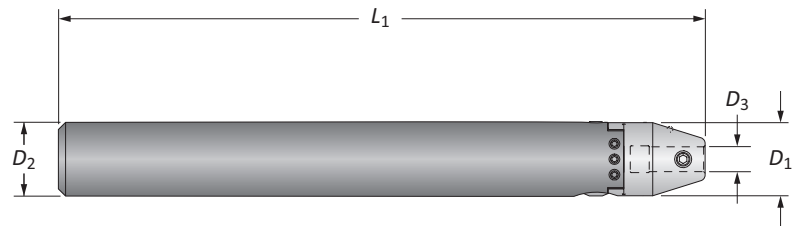

SGL Style

D ₁ Range	D ₃	Boring Bar		Part No.
		L ₁	D ₂	
0.050 - 0.380	0.125	5.25	0.625	CBR-0625SSG
0.050 - 0.470	0.250	6.50	0.750	CBR-0750SH
0.120 - 0.640	0.375	8.69	1.000	CBR-1000SA
0.250 - 0.800	0.500	10.60	1.250	CBR-1250SB

F
THREADING

X
SPECIALS

B20: 80 - 81 B20: 47 - 59 B20: 60 - 67

◇ = Imperial (in)
▲ = Metric (mm)
Inserts sold separately

Cri-Bar Adjustable Boring Bar Replacement Parts

Round Shank

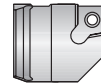
**1** Body**2** Insert Holder**3** Dial Screw

Standard Adjusting

	Bar Part No.	Hardware Kit	Components			Torx Screw	Torx Wrench
			1	2	3		
i	CBR-0625CP	CB0625-HDW	CBR0625-BD	CB0750CP-IH	DS-MDB0750	TXS-116-1	8T-7
	CBR-0625TP	CB0625-HDW	CBR0625-BD	CB0750TP-IH	DS-MDB0750	TXS-116-1	8T-7
	CBR-0750CP	CB0750-HDW	CBR0750-BD	CB0750CP-IH	DS-MDB0750	TXS-116-1	8T-7
	CBR-0750TP	CB0750-HDW	CBR0750-BD	CB0750TP-IH	DS-MDB0750	TXS-116-1	8T-7
	CBR-1000CP	CB1000-HDW	CBR1000-BD	CB1000CP-IH	DS-MDB1000	TXS-116-1	8T-7
	CBR-1000TP	CB1000-HDW	CBR1000-BD	CB1000TP-IH	DS-MDB1000	TXS-116-1	8T-7
	CBR-1250CP	CB1250-HDW	CBR1250-BD	CB1250CP-IH	DS-MDB1000	TXS-116-1	8T-7
	CBR-1250TP	CB1250-HDW	CBR1250-BD	CB1250TP-IH	DS-MDB1000	TXS-116-1	8T-7

**1** Body**2** Insert Holder**3** Dial Screw**4** Micro Dial Screw

Micro Adjusting

	Bar Part No.	Hardware Kit	Components				Wedge	Torx Screw	Torx Wrench
			1	2	3	4			
i	CBR-1000CPMA	CB1000-HDW	CBR1000-BD	CB1000CPMA-IH	DS-MDB1000	DS-MA1500	MAW-1000	TXS-116-1	8T-7
	CBR-1000TPMA	CB1000-HDW	CBR1000-BD	CB1000TPMA-IH	DS-MDB1000	DS-MA1500	MAW-1000	TXS-116-1	8T-7
	CBR-1250CPMA	CB1250-HDW	CBR1250-BD	CB1250CPMA-IH	DS-MDB1000	DS-MA1500	MAW-1000	TXS-116-1	8T-7
	CBR-1250TPMA	CB1250-HDW	CBR1250-BD	CB1250TPMA-IH	DS-MDB1000	DS-MA1500	MAW-1000	TXS-116-1	8T-7

**1** Body**2** Bar Holder**3** Dial Screw

SGL Style

	Bar Part No.	Hardware Kit	Components		
			1	2	3
i	CBR-0625SG	CB0625-HDW	CBR0625-BD	SGL0625G-BH	DS-MDB0750
	CBR-0750SH	CB0750-HDW	CBR0750-BD	SGL0750H-BH	DS-MDB0750
	CBR-1000SA	CB1000-HDW	CBR1000-BD	SGL1000A-BH	DS-MDB1000
	CBR-1250SB	CB1250-HDW	CBR1250-BD	SGL1250B-BH	DS-MDB1000

i = Imperial (in)**m** = Metric (mm)

Screws sold in multiples of 10

Cri-Bar Adjustable Boring Bars

Square Shank | Bore Diameter Range: 0.050" - 1.600"

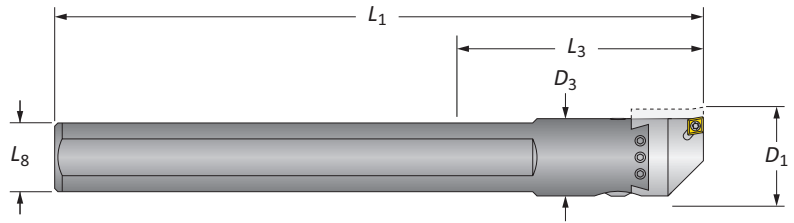

Standard Adjusting

D ₁ Range	Boring Bar					Part No.	IC	Insert	
	D ₃	L ₁	L ₃	L ₈	T ₁			Style	
0.672 - 0.944	0.625	5.25	3.000	0.541	CBS-0625CP*	0.250	0.094	◇	CP or CC
0.672 - 0.944	0.625	5.25	3.000	0.541	CBS-0625TP	0.250	0.094	△	TP
0.825 - 1.087	0.750	6.31	4.000	0.660	CBS-0750CP	0.250	0.094	◇	CP or CC
0.825 - 1.087	0.750	6.31	4.000	0.660	CBS-0750TP	0.250	0.094	△	TP
1.050 - 1.320	1.000	8.25	5.000	0.883	CBS-1000CP	0.250	0.094	◇	CP or CC
1.050 - 1.320	1.000	8.25	5.000	0.883	CBS-1000TP	0.250	0.094	△	TP
1.300 - 1.600	1.250	10.31	6.500	1.100	CBS-1250CP	0.250	0.094	◇	CP or CC
1.300 - 1.600	1.250	10.31	6.500	1.100	CBS-1250TP	0.250	0.094	△	TP

*CBS-0625 style boring system has a minimum bore diameter of 0.750" when using a CC style insert
Imperial (in) = 0.001" adjustment on diameter

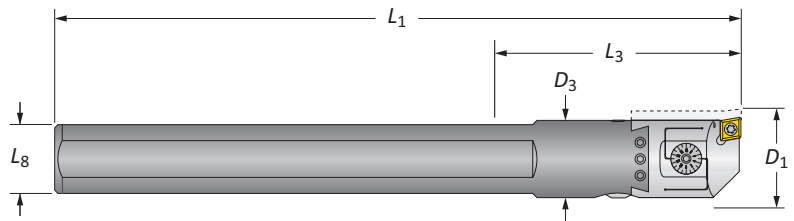

Micro Adjusting

D ₁ Range	Boring Bar					Part No.	IC	Insert	
	D ₃	L ₁	L ₃	L ₈	T ₁			Style	
1.050 - 1.320	1.000	8.95	3.000	0.883	CBS-1000CPMA	0.250	0.094	◇	CP or CC
1.050 - 1.320	1.000	8.95	4.000	0.883	CBS-1000TPMA	0.250	0.094	△	TP
1.300 - 1.600	1.250	11.00	5.000	1.100	CBS-1250CPMA	0.250	0.094	◇	CP or CC
1.300 - 1.600	1.250	11.00	6.500	1.100	CBS-1250TPMA	0.250	0.094	△	TP

The total range of the micro adjustment is 0.006" (0.150mm) on diameter
Imperial (in) = 0.00005" adjustment on diameter

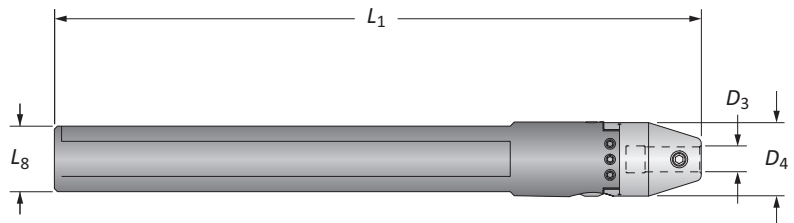

SGL Style

D ₁ Range	Boring Bar					Part No.
	D ₃	D ₄	L ₁	L ₈		
0.050 - 0.380	0.125	0.625	5.25	0.541	CBS-0625SG	
0.050 - 0.470	0.250	0.750	6.50	0.660	CBS-0750SH	
0.120 - 0.640	0.375	1.000	8.69	0.883	CBS-1000SA	
0.250 - 0.800	0.500	1.250	10.60	1.100	CBS-1250SB	

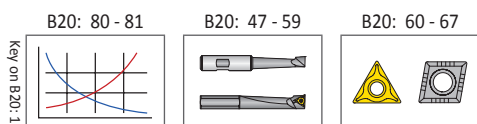

ⓘ = Imperial (in)
Ⓜ = Metric (mm)

Inserts sold separately

A DRILLING
B BORING
C REAMING
D BURNISHING
E THREADING
X SPECIALS

Cri-Bar Adjustable Boring Bar Replacement Parts

Square Shank



1 Body

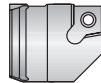

2 Insert Holder



3 Dial Screw

Standard Adjusting

Bar Part No.	Hardware Kit	Components			Torx Screw	Torx Wrench
		1	2	3		
CBS-0625CP	CB0625-HDW	CBS0625-BD	CB0750CP-IH	DS-MDB0750	TXS-116-1	8T-7
CBS-0625TP	CB0625-HDW	CBS0625-BD	CB0750TP-IH	DS-MDB0750	TXS-116-1	8T-7
CBS-0750CP	CB0750-HDW	CBS0750-BD	CB0750CP-IH	DS-MDB0750	TXS-116-1	8T-7
CBS-0750TP	CB0750-HDW	CBS0750-BD	CB0750TP-IH	DS-MDB0750	TXS-116-1	8T-7
CBS-1000CP	CB1000-HDW	CBS1000-BD	CB1000CP-IH	DS-MDB1000	TXS-116-1	8T-7
CBS-1000TP	CB1000-HDW	CBS1000-BD	CB1000TP-IH	DS-MDB1000	TXS-116-1	8T-7
CBS-1250CP	CB1250-HDW	CBS1250-BD	CB1250CP-IH	DS-MDB1000	TXS-116-1	8T-7
CBS-1250TP	CB1250-HDW	CBS1250-BD	CB1250TP-IH	DS-MDB1000	TXS-116-1	8T-7

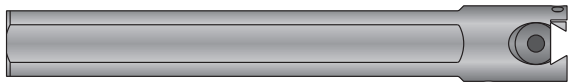

1 Body

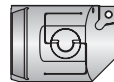

2 Insert Holder



3 Dial Screw



4 Micro Dial Screw

Micro Adjusting

Bar Part No.	Hardware Kit	Components				Wedge	Torx Screw	Torx Wrench
		1	2	3	4			
CBS-1000CPMA	CB1000-HDW	CBS1000-BD	CB1000CPMA-IH	DS-MDB1000	DS-MA1500	MAW-1000	TXS-116-1	8T-7
CBS-1000TPMA	CB1000-HDW	CBS1000-BD	CB1000TPMA-IH	DS-MDB1000	DS-MA1500	MAW-1000	TXS-116-1	8T-7
CBS-1250CPMA	CB1250-HDW	CBS1250-BD	CB1250CPMA-IH	DS-MDB1000	DS-MA1500	MAW-1000	TXS-116-1	8T-7
CBS-1250TPMA	CB1250-HDW	CBS1250-BD	CB1250TPMA-IH	DS-MDB1000	DS-MA1500	MAW-1000	TXS-116-1	8T-7

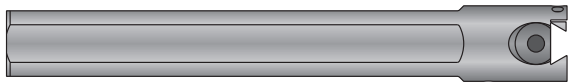

1 Body



2 Bar Holder



3 Dial Screw

SGL Style

Bar Part No.	Hardware Kit	Components		
		1	2	3
CBS-0625SG	CB0625-HDW	CBS0625-BD	SGL0625G-BH	DS-MDB0750
CBS-0750SH	CB0750-HDW	CBS0750-BD	SGL0750H-BH	DS-MDB0750
CBS-1000SA	CB1000-HDW	CBS1000-BD	SGL1000A-BH	DS-MDB1000
CBS-1250SB	CB1250-HDW	CBS1250-BD	SGL1250B-BH	DS-MDB1000

i = Imperial (in)
m = Metric (mm)

Screws sold in multiples of 10

MD Adjustable Boring Bars

Square Shank | Bore Diameter Range: 0.250" - 1.250"

A DRILLING

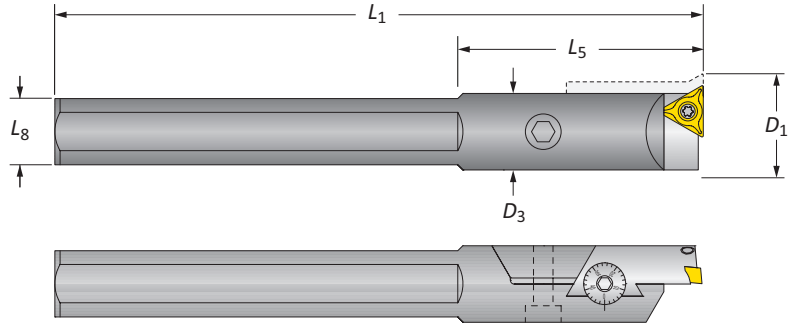
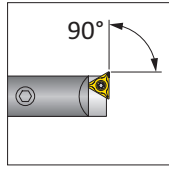

B BORING

	Boring Bar					Part No.	Insert		
	D_1 Range	D_3	L_1	L_5	D_2		IC	T_1	Style
i	0.700 - 0.960	0.625	5.25	3.000	0.541	MDB-0625CP*	0.250	0.094	◇ CP or CC
	0.710 - 0.960	0.625	5.25	3.000	0.541	MDB-0625TP	0.250	0.094	△ TP
	0.850 - 1.200	0.750	6.31	4.000	0.660	MDB-0750CP	0.375	0.156	◇ CP or CC
	0.890 - 1.280	0.750	6.31	4.000	0.660	MDB-0750TP	0.375	0.125	△ TP
	1.100 - 1.670	1.000	8.25	5.000	0.883	MDB-1000CP	0.375	0.156	◇ CP or CC
	1.130 - 1.650	1.000	8.25	5.000	0.883	MDB-1000TP	0.375	0.125	△ TP
	1.370 - 2.330	1.250	10.31	6.500	1.100	MDB-1250CP	0.375	0.156	◇ CP or CC
	1.400 - 2.370	1.250	10.31	6.500	1.100	MDB-1250TP	0.375	0.125	△ TP
m	18 - 27	16	133	3.000	14	MDB-16MT	6.35	2.38	△ TP
	22 - 33	20	160	4.000	18	MDB-20MT	9.53	3.96	△ TP
	27 - 42	25	210	5.000	23	MDB-25MT	9.53	3.96	△ TP
	33 - 60	32	260	6.500	28	MDB-32MT	9.53	3.96	△ TP

*MDB-0625CP style boring system has a minimum bore diameter of 0.750" when using a CC style insert

Imperial (in) = 0.001" adjustment on diameter

Metric (mm) = 0.02mm adjustment on diameter

C REAMING

D BURNISHING

F THREADING

X SPECIALS

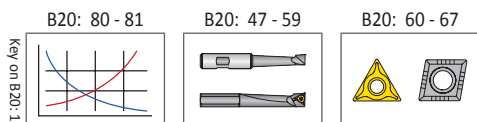

i = Imperial (in)
m = Metric (mm)
Inserts sold separately



MD Adjustable Boring Bar Replacement Parts

Square Shank



1 Body

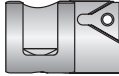

2 Insert Holder



3 Dial Screw

Standard Adjusting

Bar Part No.	Components			Wedge	Torx Screw (10)	Torx Wrench	
	1	2	3				
i	MDB-0625CP	MDB0625-BD	MD0625CP-IH	DS-MDB0625	MDB0625-WEDGE	TXS-116-1	8T-7
	MDB-0625TP	MDB0625-BD	MD0625TP-IH	DS-MDB0625	MDB0625-WEDGE	TXS-116-1	8T-7
	MDB-0750CP	MDB0750-BD	MD0750CP-IH	DS-MDB0750	MDB0750-WEDGE	TXS-009-1	8T-15
	MDB-0750TP	MDB0750-BD	MD0750TP-IH	DS-MDB0750	MDB0750-WEDGE	TXS-100-1	8T-20
	MDB-1000CP	MDB1000-BD	MD1000CP-IH	DS-MDB1000	MDB1000-WEDGE	TXS-009-1	8T-15
	MDB-1000TP	MDB-1000BD	MD1000TP-IH	DS-MDB1000	MDB1000-WEDGE	TXS-100-1	8T-20
	MDB-1250CP	MDB1250-BD	MD1250CP-IH	DS-MDB1250	MDB1250-WEDGE	TXS-009-1	8T-15
MDB-1250TP	MDB1250-BD	MD1250TP-IH	DS-MDB1250	MDB1250-WEDGE	TXS-100-1	8T-20	
m	MDB-16MT	MDB16M-BD	MD16MTP-IH	DS-MDB16M	MDB16M-WEDGE	TXS-116-1	8T-7
	MDB-20MT	MDB20M-BD	MD20MTP-IH	DS-MDB20M	MDB20M-WEDGE	TXS-100-1	8T-20
	MDB-25MT	MDB25M-BD	MD25MTP-IH	DS-MDB25M	MDB25M-WEDGE	TXS-100-1	8T-20
	MDB-32MT	MDB32M-BD	MD32MTP-IH	DS-MDB32M	MDB32M-WEDGE	TXS-100-1	8T-20

i = Imperial (in)
m = Metric (mm)

Screws sold in multiples of 10

Criterion Shanks

V Flange | BT Flange

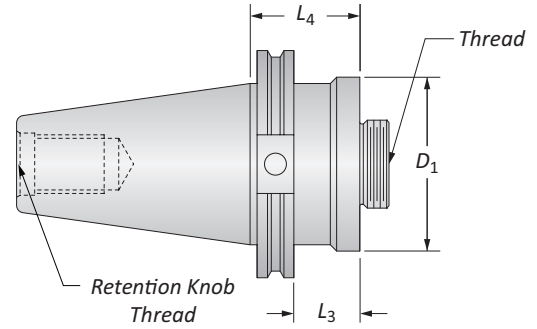

V Flange Shank

Style	D_1	L_3	Shank			Retention Knob Thread	Part No.
			L_4	Thread			
CAT40	1.50	0.350	1.75	7/8"-20	5/8"-11	CB1500-CV40	
CAT40	2.00	1.000	1.88	7/8"-20	5/8"-11	CB2000-CV40	
CAT40	2.50	1.000	1.88	1-1/2"-18	5/8"-11	CB2500-CV40	
CAT40	3.00	1.750	1.88	1-1/2"-18	5/8"-11	CB3000-CV40	
i CAT50	1.50	0.350	1.75	7/8"-20	1"-8	CB1500-CV50	
CAT50	2.00	1.000	1.88	7/8"-20	1"-8	CB2000-CV50	
CAT50	2.50	1.000	1.88	1-1/2"-18	1"-8	CB2500-CV50	
CAT50	3.00	1.750	1.88	1-1/2"-18	1"-8	CB3000-CV50	
CAT50	3.38	1.250	2.13	2-1/4"-10	1"-8	CB6000-CV50	

NOTE: Taper ground to AT3 tolerance

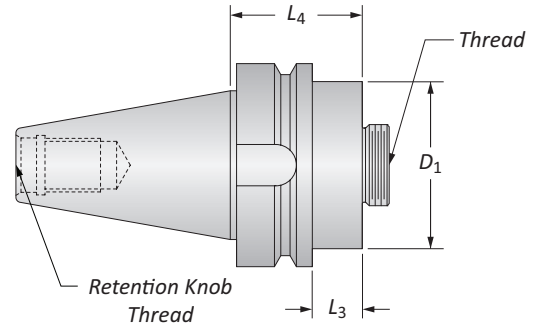

BT Flange Shank

Style	D_1	L_3	Shank			Retention Knob Thread	Part No.
			L_4	Thread			
BT30	1.50	0.859	1.75	7/8"-20	M12 x 1.75	CB1500-BT30	
BT40	1.50	0.422	1.75	7/8"-20	M16 x 2	CB1500-BT40	
BT40	2.00	1.900	1.56	7/8"-20	M16 x 2	CB2000-BT40	
BT40	2.50	1.900	2.06	1-1/2"-18	M16 x 2	CB2500-BT40	
i BT40	3.00	1.900	2.06	1-1/2"-18	M16 x 2	CB3000-BT40	
BT50	1.50	0.236	1.75	7/8"-20	M24 x 3	CB1500-BT50	
BT50	2.00	0.040	1.56	7/8"-20	M24 x 3	CB2000-BT50	
BT50	3.00	1.900	2.06	1-1/2"-18	M24 x 3	CB3000-BT50	
BT50	3.38	0.625	2.13	2-1/4"-10	M24 x 3	CB6000-BT50	

NOTE: Taper ground to AT3 tolerance

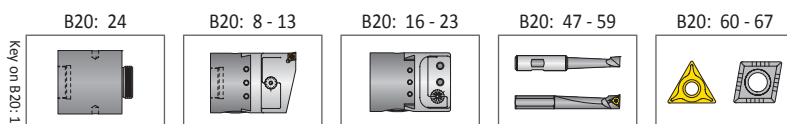

i = Imperial (in)
m = Metric (mm)



Criterion Shanks

DIN 69871A | DIN 2080

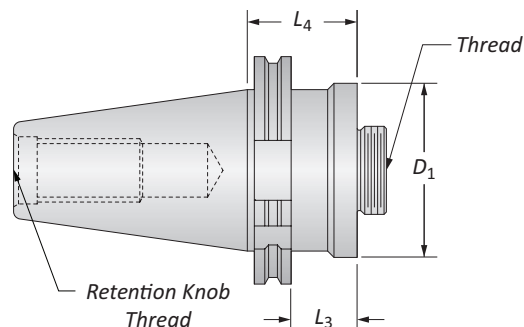

DIN 69871A Shank

	Style	D ₁	Shank			Retention Knob Thread	Part No.
			L ₃	L ₄	Thread		
Ⓜ	DIN 40	38.00	19.00	38.40	7/8"-20	M16 x 2.0	CB038M-DIN40
	DIN 40	50.00	22.00	41.50	7/8"-20	M16 x 2.0	CB050M-DIN40
	DIN 40	76.00	45.00	48.00	1-1/2"-18	M16 x 2.0	CB076M-DIN40
	DIN 50	38.00	19.00	38.40	7/8"-20	M24 x 3.0	CB038M-DIN50
	DIN 50	50.00	22.00	41.50	7/8"-20	M24 x 3.0	CB050M-DIN50
	DIN 50	76.00	22.00	48.00	1-1/2"-18	M24 x 3.0	CB076M-DIN50

NOTE: Taper ground to AT3 tolerance

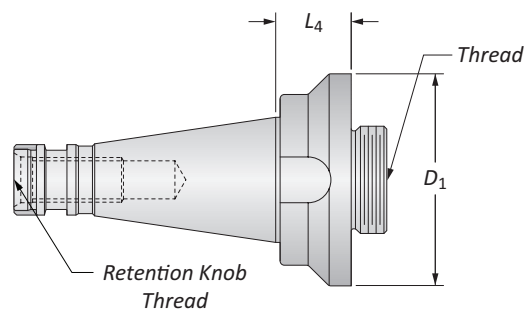

DIN 2080 Shank

	Style	D ₁	Shank			Retention Knob Thread	Part No.
			L ₃	L ₄	Thread		
Ⓜ	SK-30	38.00	11.00	19.60	7/8"-20	1/2"-13	CB038M-ISO30
	SK-30	50.00	17.00	25.70	7/8"-20	1/2"-13	CB050M-ISO30
	SK-40	38.00	11.00	21.10	7/8"-20	5/8"-11	CB038M-ISO40
	SK-40	50.00	11.00	27.70	7/8"-20	5/8"-11	CB050M-ISO40
	SK-40	76.00	22.00	27.70	1-1/2"-18	5/8"-11	CB076M-ISO40
	SK-50	38.00	11.00	39.40	7/8"-20	1"-8	CB038M-ISO50
	SK-50	50.00	11.00	39.40	7/8"-20	1"-8	CB050M-ISO50
	SK-50	76.00	36.00	39.40	1-1/2"-18	1"-8	CB076M-ISO50

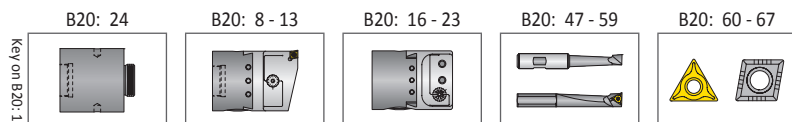

Key on B20-1

Ⓜ = Imperial (in)
Ⓜ = Metric (mm)

Criterion Shanks

Morse Taper | NMTB Taper

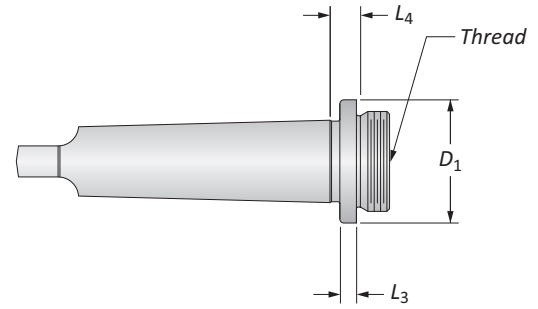

Morse Taper Shank

Style	D ₁	Shank			Thread	Part No.
		L ₃	L ₄	Thread		
2 Taper	1.11	0.250	0.44	7/8"-20	MT2-375THD87520*	
2 Taper	1.11	0.250	0.44	7/8"-20	MT2-087520	
3 Taper	1.11	-	0.44	7/8"-20	MT3-087520	
3 Taper	1.86	0.250	0.44	1-1/2"-18	MT3-150018	
4 Taper	1.11	0.250	0.25	7/8"-20	MT4-087520	
4 Taper	1.86	0.250	0.50	1-1/2"-18	MT4-150018	
5 Taper	1.86	0.250	0.62	1-1/2"-18	MT5-150018	

*Item features a 3/8-16 thread instead of tang

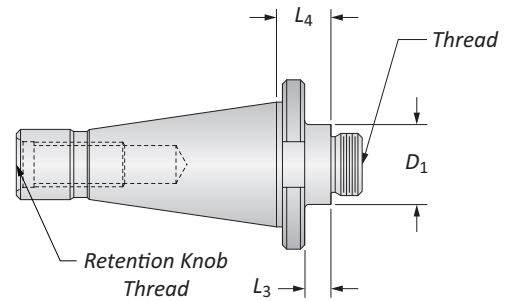

NMTB Taper Shank

Style	D ₁	Shank			Retention Knob Thread	Part No.
		L ₃	L ₄	Thread		
NMTB 30	1.11	0.300	0.78	7/8"-20	1/2"-13	NMTB30-087520
NMTB 30	1.86	0.900	1.05	1-1/2"-18	1/2"-13	NMTB30-150018
NMTB 40	1.11	0.300	0.77	7/8"-20	5/8"-11	NMTB40-087520
NMTB 40	1.86	0.625	1.04	1-1/2"-18	5/8"-11	NMTB40-150018
NMTB 50	1.11	0.500	1.25	7/8"-20	1"-8	NMTB50-087520
NMTB 50	1.86	0.500	1.25	1-1/2"-18	1"-8	NMTB50-150018
NMTB 50	3.38	0.500	1.25	2-1/4"-10	1"-8	NMTB50-225010

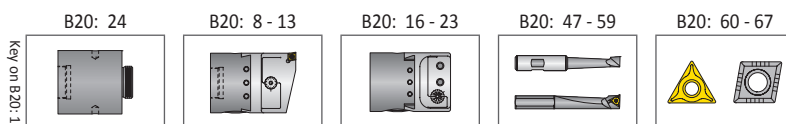

key on B20: 1

i = Imperial (in)
m = Metric (mm)



Criterion Shanks

HSK

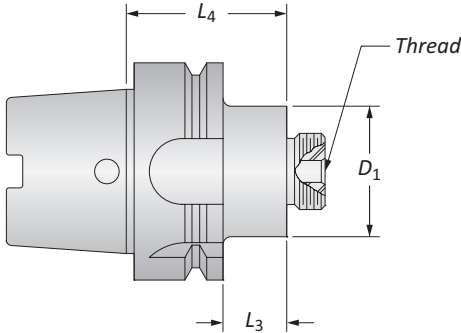

HSK Shank

	Style	Shank				Part No.
		D_1	L_3	L_4	Thread	
i	HSK63	1.50	0.700	1.75	7/8"-20	CB1500-HSK63A
	HSK63	2.00	0.700	1.75	7/8"-20	CB2000-HSK63A
	HSK63	3.00	2.000	2.25	1-1/2"-18	CB3000-HSK63A
	HSK100	1.50	0.500	1.75	7/8"-20	CB1500-HSK100A
	HSK100	2.00	0.500	2.25	7/8"-20	CB2000-HSK100A
	HSK100	3.00	0.500	2.25	1-1/2"-18	CB3000-HSK100A

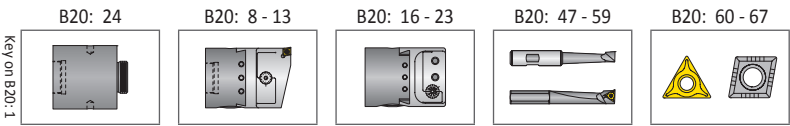

i = Imperial (in)
 m = Metric (mm)

Criterion Shanks

R-8 | Straight

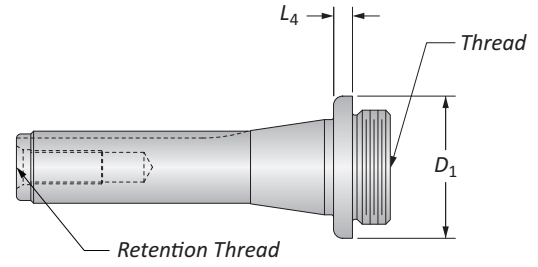

R-8 Shank

	Shank				Part No.
	D_1	L_4	Thread	Retention Thread	
i	1.11	0.47	7/8"-20	7/16"-20	R8-087520
	1.86	0.37	1-1/2"-18	7/16"-20	R8-150018

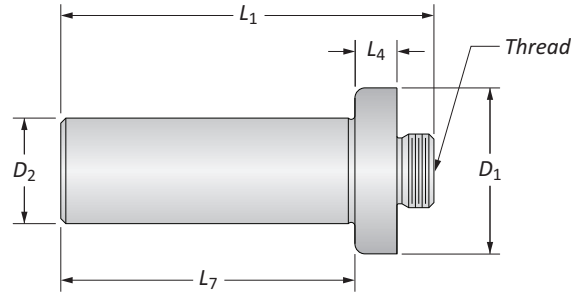

Straight Shank

	Shank						Part No.
	D_1	D_2	L_4	L_7	L_1	Thread	
	1.11	0.500	0.250	2.000	2.250	7/8"-20	SS0500-087520
	1.11	0.625	0.250	2.370	2.630	7/8"-20	SS0625-087520
	1.11	0.750	0.250	2.750	3.000	7/8"-20	SS0750-087520
	1.11	1.000	0.250	3.120	3.370	7/8"-20	SS1000-087520
i	1.86	0.750	0.250	3.120	3.370	1-1/2"-18	SS0750-150018
	1.86	1.000	0.250	3.120	3.370	1-1/2"-18	SS1000-150018
	1.86	1.250	0.250	3.870	4.130	1-1/2"-18	SS1250-150018
	1.86	1.500	0.250	4.630	4.880	1-1/2"-18	SS1500-150018
	1.86	2.000	-	6.380	6.380	1-1/2"-18	SS2000-150018

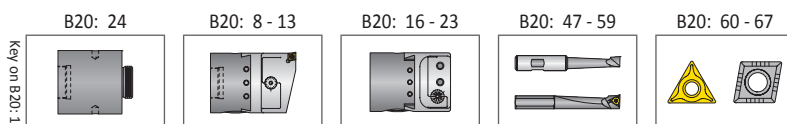

i = Imperial (in)
m = Metric (mm)

Criterion Boring Bars Nomenclature

Criterion Boring Bars

CBT	00800500	G	QL
1	2	3	4

<p>1. Boring Bar Style</p> <p>CBT = Solid carbide boring tool SBT = Steel shank brazed carbide boring tool TA = Triangle insert boring tool (standard bore depth) TAS = Triangle insert boring tool (short bore depth)</p>	<p>2. Max Bore Depth</p>	<p>3. Shank Diameter</p> <table border="1"> <thead> <tr> <th>Imperial</th> <th>Metric</th> </tr> </thead> <tbody> <tr> <td>A = 0.375</td> <td>A = 10mm</td> </tr> <tr> <td>B = 0.500</td> <td>B = 12mm</td> </tr> <tr> <td>C = 0.625</td> <td>C = 16mm</td> </tr> <tr> <td>D = 0.750</td> <td>D = 20mm</td> </tr> <tr> <td>E = 1.000</td> <td>E = 25mm</td> </tr> <tr> <td>F = 1.500</td> <td></td> </tr> <tr> <td>G = 0.125</td> <td></td> </tr> <tr> <td>H = 0.250</td> <td></td> </tr> </tbody> </table>	Imperial	Metric	A = 0.375	A = 10mm	B = 0.500	B = 12mm	C = 0.625	C = 16mm	D = 0.750	D = 20mm	E = 1.000	E = 25mm	F = 1.500		G = 0.125		H = 0.250		<p>4. Type</p> <p>QL = Qualified length HB = Helical back rake S = Square shank</p>
Imperial	Metric																				
A = 0.375	A = 10mm																				
B = 0.500	B = 12mm																				
C = 0.625	C = 16mm																				
D = 0.750	D = 20mm																				
E = 1.000	E = 25mm																				
F = 1.500																					
G = 0.125																					
H = 0.250																					

Criterion Boring Bars

CFX	500	CS
1	2	3

<p>1. Boring Bar Style</p> <p>CFX = 80° rhombic insert (long bore depth) TFX = Triangle insert (long bore depth) CHB = Cross hole boring bar BFB = Boring and facing bar</p>	<p>2. Shank Diameter</p> <table border="1"> <thead> <tr> <th>Imperial</th> <th>Metric</th> </tr> </thead> <tbody> <tr> <td>0375 = 0.375</td> <td>012M = 12mm</td> </tr> <tr> <td>0500 = 0.500</td> <td>020M = 20mm</td> </tr> <tr> <td>0625 = 0.625</td> <td>025M = 25mm</td> </tr> <tr> <td>0750 = 0.750</td> <td></td> </tr> <tr> <td>1000 = 1.000</td> <td></td> </tr> <tr> <td>1500 = 1.500</td> <td></td> </tr> </tbody> </table>	Imperial	Metric	0375 = 0.375	012M = 12mm	0500 = 0.500	020M = 20mm	0625 = 0.625	025M = 25mm	0750 = 0.750		1000 = 1.000		1500 = 1.500		<p>3. Material</p> <p>CS = Carbide shank HM = Heavy metal</p>
Imperial	Metric															
0375 = 0.375	012M = 12mm															
0500 = 0.500	020M = 20mm															
0625 = 0.625	025M = 25mm															
0750 = 0.750																
1000 = 1.000																
1500 = 1.500																



Standard



Steel



Heavy Metal



Carbide Shank



Cross Hole



Boring and Facing



Solid Carbide



Qualified Length



Helical Rake

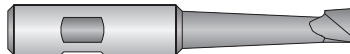

Round Shank



Square Shank



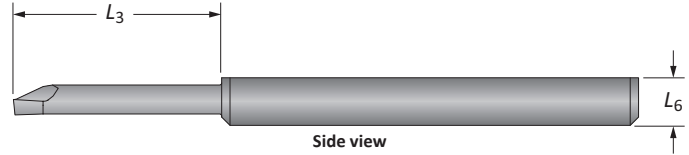
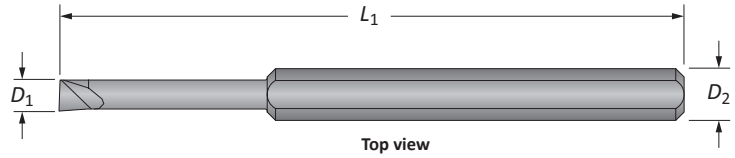
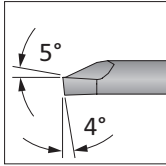
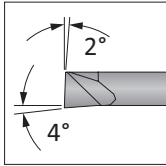

Criterion Boring Bars

Carbide | Solid Carbide



Boring Bar					
D_1	L_3	L_1	L_6	D_2	Part No.
0.050	0.150	1.500	0.115	0.125	CBT-00500150G
0.050	0.300	1.500	0.115	0.125	CBT-00500300G
0.050	0.400	1.500	0.115	0.125	CBT-00500400G
0.060	0.150	1.500	0.115	0.125	CBT-00600150G
0.060	0.300	1.500	0.115	0.125	CBT-00600300G
0.060	0.500	1.500	0.115	0.125	CBT-00600500G
0.080	0.150	1.500	0.115	0.125	CBT-00800150G
0.080	0.300	1.500	0.115	0.125	CBT-00800300G
i 0.080	0.500	1.500	0.115	0.125	CBT-00800500G
0.100	0.200	1.500	0.115	0.125	CBT-01000200G
0.100	0.400	1.500	0.115	0.125	CBT-01000400G
0.100	0.600	1.500	0.115	0.125	CBT-01000600G
0.100	0.700	1.500	0.115	0.125	CBT-01000700G
0.110	0.200	1.500	0.115	0.125	CBT-01100200G
0.110	0.400	1.500	0.115	0.125	CBT-01100400G
0.110	0.600	1.500	0.115	0.125	CBT-01100600G
0.110	0.700	1.500	0.115	0.125	CBT-01100700G

Adapters

D_1	 Style 1	 Style 2	 Style 3	 Style 4
0.125	-	-	BTH-01250250	BTH-01250375
i 0.125	-	-	-	BTH-01250500
0.125	-	-	-	BTH-01250625
0.125	-	-	-	BTH-01250750

For complete adapter details, see page B20: 25

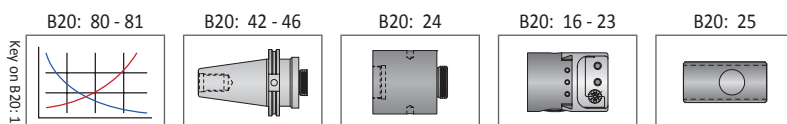

i = Imperial (in)
m = Metric (mm)



Criterion Boring Bars

Carbide | Solid Carbide

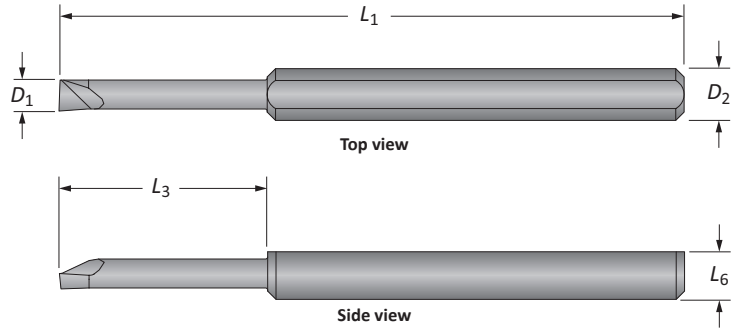
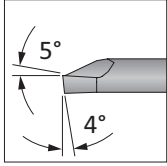
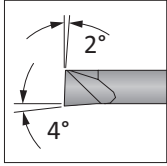

i	Boring Bar					Part No.
	D ₁	L ₃	L ₁	L ₆	D ₂	
	0.120	0.250	2.500	0.230	0.250	CBT-01200250H
	0.120	0.375	2.500	0.230	0.250	CBT-01200375H
	0.120	0.500	2.500	0.230	0.250	CBT-01200500H
	0.120	0.625	2.500	0.230	0.250	CBT-01200625H
	0.120	0.750	2.500	0.230	0.250	CBT-01200750H
	0.140	0.250	2.500	0.230	0.250	CBT-01400250H
	0.140	0.375	2.500	0.230	0.250	CBT-01400375H
	0.140	0.500	2.500	0.230	0.250	CBT-01400500H
	0.140	0.625	2.500	0.230	0.250	CBT-01400625H
	0.140	0.750	2.500	0.230	0.250	CBT-01400750H
	0.160	0.375	2.500	0.230	0.250	CBT-01600375H
	0.160	0.500	2.500	0.230	0.250	CBT-01600500H
	0.160	0.625	2.500	0.230	0.250	CBT-01600625H
	0.160	0.750	2.500	0.230	0.250	CBT-01600750H
	0.160	0.875	2.500	0.230	0.250	CBT-01600875H
	0.180	0.500	2.500	0.230	0.250	CBT-01800500H
	0.180	0.625	2.500	0.230	0.250	CBT-01800625H
	0.180	0.750	2.500	0.230	0.250	CBT-01800750H
	0.180	0.875	2.500	0.230	0.250	CBT-01800875H
	0.180	1.000	2.500	0.230	0.250	CBT-01801000H
	0.180	1.125	2.500	0.230	0.250	CBT-01801125H
	0.200	0.500	2.500	0.230	0.250	CBT-02000500H
	0.200	0.625	2.500	0.230	0.250	CBT-02000625H
	0.200	0.750	2.500	0.230	0.250	CBT-02000750H
	0.200	0.875	2.500	0.230	0.250	CBT-02000875H
	0.200	1.000	2.500	0.230	0.250	CBT-02001000H
	0.200	1.250	2.500	0.230	0.250	CBT-02001250H

Adapters

D ₁	Style 1	Style 2	Style 3	Style 4
0.250	BTH-02500375	-	-	BTH-02500625
0.250	BTH-02500500	-	-	BTH-02500750

For complete adapter details, see page B20: 25

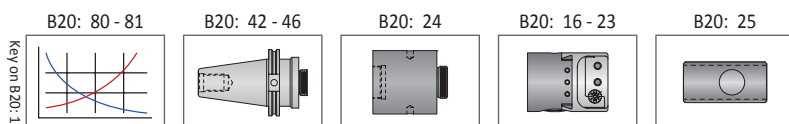

i = Imperial (in)
m = Metric (mm)

Criterion Boring Bars

Carbide | Helical Rake

A
DRILLING

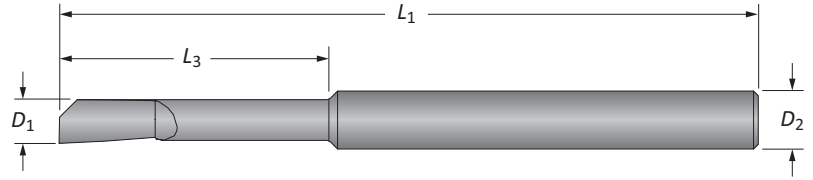

B
BORING

	Boring Bar				Part No.
	D_1	L_3	L_1	D_2	
i	0.035	0.125	1.500	0.125 ϕ	CBT-00350125GHB
	0.035	0.187	1.500	0.125 ϕ	CBT-00350187GHB
	0.040	0.187	1.500	0.125 ϕ	CBT-00400187GHB
	0.040	0.250	1.500	0.125 ϕ	CBT-00400250GHB
	0.050	0.312	1.500	0.125 ϕ	CBT-00500312GHB
	0.060	0.375	1.500	0.125 ϕ	CBT-00600375GHB
	0.070	0.437	1.500	0.125 ϕ	CBT-00700437GHB
	0.080	0.500	1.500	0.125 ϕ	CBT-00800500GHB
	0.090	0.500	1.500	0.125 ϕ	CBT-00900500GHB
	0.100	0.562	1.500	0.125 ϕ	CBT-01000562GHB
	0.120	0.625	1.500	0.125 ϕ	CBT-01200625GHB
	0.120	1.000	1.500	0.125 ϕ	CBT-01201000GHB

C
REAMING

Tool Holders

	Holder			Part No.
	D_1	D_2	L_1	
i	0.250	0.410 ϕ	1.275	CHD-0250QL
	0.375	0.410 ϕ	1.970	CHD-0375QL
	0.500	0.410 ϕ	1.970	CHD-0500QL
	0.625	0.410 ϕ	2.300	CHD-0625QL
	0.750	0.410 ϕ	2.300	CHD-0750QL

Tool holder comes with collet nut (CHD-0250CN) and wrench (CHD-125CNW)
Collet sold separately

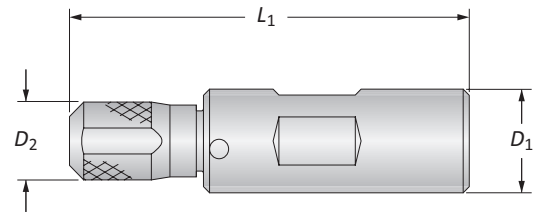

F
THREADING

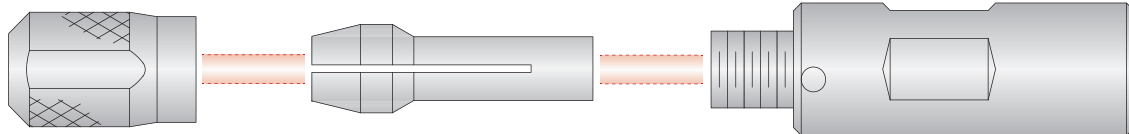

Collet Nut
CHD-0250CN

Collet
CHD-125C
(sold separately)

Tool Holder
CHD-XXXXQL

X
SPECIALS

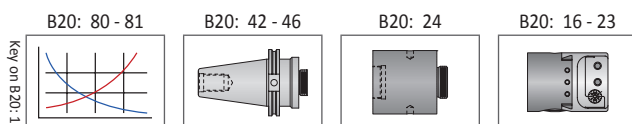

i = Imperial (in)
m = Metric (mm)



Criterion Boring Bars

Carbide | Qualified Length

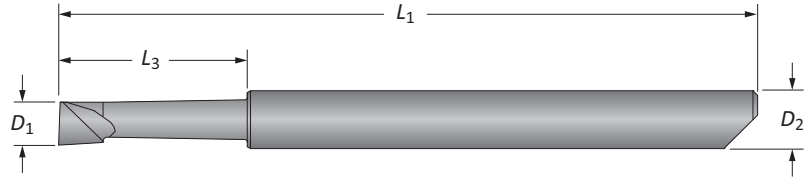
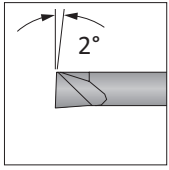

	Boring Bar				Part No.
	D_1	L_3	L_1	D_2	
i	0.050	0.150	1.500	0.125Ø	CBT-00500150GQL
	0.050	0.300	1.500	0.125Ø	CBT-00500300GQL
	0.050	0.400	1.500	0.125Ø	CBT-00500400GQL
	0.060	0.150	1.500	0.125Ø	CBT-00600150GQL
	0.060	0.300	1.500	0.125Ø	CBT-00600300GQL
	0.060	0.500	1.500	0.125Ø	CBT-00600500GQL
	0.080	0.150	1.500	0.125Ø	CBT-00800150GQL
	0.080	0.300	1.500	0.125Ø	CBT-00800300GQL
	0.080	0.500	1.500	0.125Ø	CBT-00800500GQL
	0.100	0.200	1.500	0.125Ø	CBT-01000200GQL
	0.100	0.400	1.500	0.125Ø	CBT-01000400GQL
	0.100	0.600	1.500	0.125Ø	CBT-01000600GQL
	0.100	0.700	1.500	0.125Ø	CBT-01000700GQL
	0.110	0.200	1.500	0.125Ø	CBT-01100200GQL
	0.110	0.400	1.500	0.125Ø	CBT-01100400GQL
	0.110	0.600	1.500	0.125Ø	CBT-01100600GQL
	0.110	0.700	1.500	0.125Ø	CBT-01100700GQL

Tool Holders

	Holder			Part No.
	D_1	D_2	L_1	
i	0.250	0.410Ø	1.275	CHD-0250QL
	0.375	0.410Ø	1.970	CHD-0375QL
	0.500	0.410Ø	1.970	CHD-0500QL
	0.625	0.410Ø	2.300	CHD-0625QL
	0.750	0.410Ø	2.300	CHD-0750QL

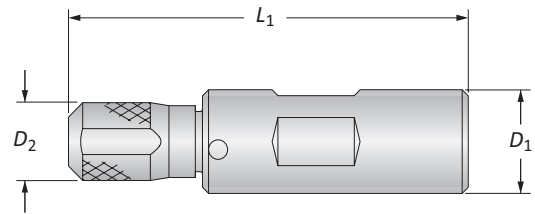

Tool holder comes with collet nut (CHD-0250CN) and wrench (CHD-125CNW)
Collet sold separately

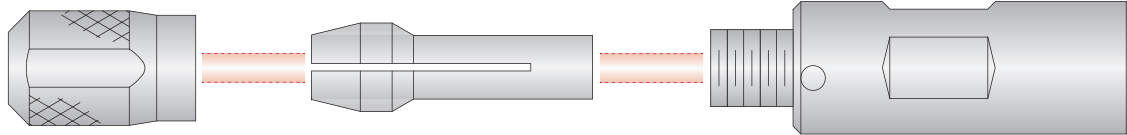

Collet Nut
CHD-0250CN

Collet
CHD-125C
(sold separately)

Tool Holder
CHD-XXXXQL

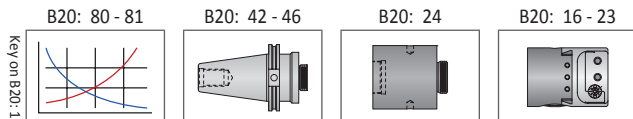

i = Imperial (in)
m = Metric (mm)

A **Criterion Boring Bars**

Brazed Carbide | Round Shank

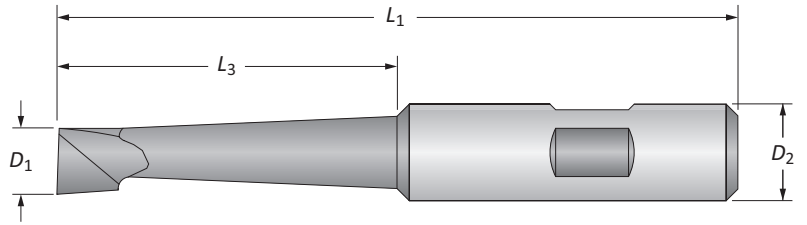
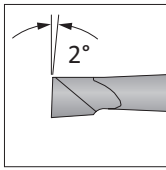

D_1	Boring Bar			Part No.
	L_3	L_1	D_2	
0.062	0.250	1.590	0.375	SBT-00620250A
0.093	0.375	1.750	0.375	SBT-00930375A
0.125	0.500	1.875	0.375	SBT-01250500A
0.187	0.812	2.156	0.375	SBT-01870812A
0.250	1.125	2.468	0.375	SBT-02501125A
0.312	1.500	2.812	0.375	SBT-03121500A
0.375	1.875	3.187	0.375	SBT-03751875A
0.500	2.312	3.500	0.375	SBT-05002312A
0.062	0.250	1.590	0.500	SBT-00620250B
0.093	0.375	1.750	0.500	SBT-00930375B
0.125	0.250	1.656	0.500	SBT-01250250B
0.125	0.500	1.875	0.500	SBT-01250500B
0.187	0.312	1.812	0.500	SBT-01870312B
0.187	0.812	2.156	0.500	SBT-01870812B
0.250	0.437	2.000	0.500	SBT-02500437B
0.250	1.125	2.468	0.500	SBT-02501125B
0.312	0.562	2.187	0.500	SBT-03120562B
0.312	1.500	2.812	0.500	SBT-03121500B
0.375	0.687	2.375	0.500	SBT-03750687B
0.375	1.750	3.187	0.500	SBT-03751750B
0.500	0.812	2.562	0.500	SBT-05000812B
<i>i</i> 0.500	2.187	3.500	0.500	SBT-05002187B
0.125	0.500	2.250	0.625	SBT-01250500C
0.187	0.812	2.562	0.625	SBT-01870812C
0.250	1.125	2.875	0.625	SBT-02501125C
0.375	1.750	3.500	0.625	SBT-03751750C
0.500	2.125	3.812	0.625	SBT-05002125C
0.625	2.500	4.125	0.625	SBT-06252500C
0.500	1.312	2.937	0.750	SBT-05001312D
0.500	2.187	3.945	0.750	SBT-05002187D
0.625	2.750	4.468	0.750	SBT-06252750D
0.750	1.531	3.156	0.750	SBT-07501531D
0.750	3.000	4.687	0.750	SBT-07503000D
1.000	1.750	3.375	0.750	SBT-10001750D
1.000	3.500	5.125	0.750	SBT-10003500D
1.250	4.000	5.562	0.750	SBT-12504000D
0.500	2.375	4.250	1.000	SBT-05002375E
0.625	2.625	4.468	1.000	SBT-06252625E
0.750	2.875	4.687	1.000	SBT-07502875E
1.000	1.750	3.375	1.000	SBT-10001750E
1.000	3.500	5.125	1.000	SBT-10003500E
1.250	1.968	3.593	1.000	SBT-12501968E
1.250	3.875	5.562	1.000	SBT-12503875E

X See adapter options on following page

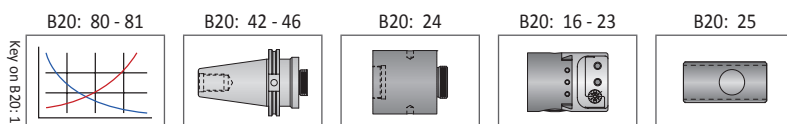

i = Imperial (in)
m = Metric (mm)

Criterion Boring Bars

Braze Carbide | Square Shank

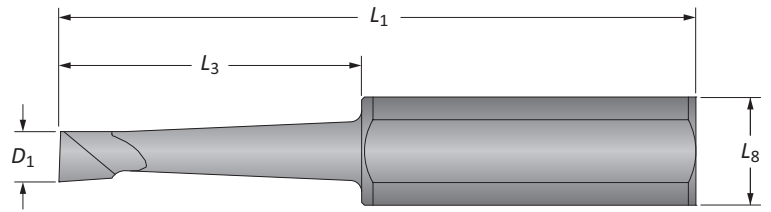
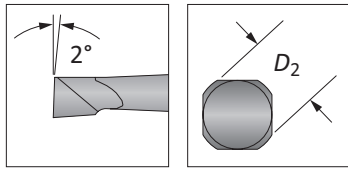

		Boring Bar				Part No.	
		D_1	L_3	L_1	L_8	D_2	
i		0.062	0.250	1.590	0.437	0.500	SBT-00620250BS
		0.093	0.375	1.750	0.437	0.500	SBT-00930375BS
		0.125	0.250	1.656	0.437	0.500	SBT-01250250BS
		0.125	0.500	1.875	0.437	0.500	SBT-01250500BS
		0.187	0.312	1.812	0.437	0.500	SBT-01870312BS
		0.187	0.812	2.156	0.437	0.500	SBT-01870812BS
		0.250	0.437	2.000	0.437	0.500	SBT-02500437BS
		0.250	1.125	2.468	0.437	0.500	SBT-02501125BS
		0.312	0.562	2.187	0.437	0.500	SBT-03120562BS
		0.312	1.500	2.812	0.437	0.500	SBT-03121500BS
		0.375	0.687	2.375	0.437	0.500	SBT-03750687BS
		0.375	1.750	3.187	0.437	0.500	SBT-03751750BS
		0.500	0.812	2.562	0.437	0.500	SBT-05000812BS
		0.500	2.187	3.500	0.437	0.500	SBT-05002187BS
	m		3	12	48	8	10
		4	20	55	8	10	SBT-04020MA
		6	28	62	8	10	SBT-06028MA
		8	37	71	8	10	SBT-08037MA
		10	48	81	8	10	SBT-10048MA
		12	55	90	8	10	SBT-12055MA
		3	12	48	10	12	SBT-03012MB
		4	20	55	10	12	SBT-04020MB
		6	28	62	10	12	SBT-06028MB
		8	37	71	10	12	SBT-08037MB
		10	48	81	10	12	SBT-10048MB
		12	55	90	10	12	SBT-12055MB
m		12	63	107	18	20	SBT-12063MD
		16	71	113	18	20	SBT-16071MD
		19	78	119	18	20	SBT-19078MD
		25	90	130	18	20	SBT-25090MD
		32	100	141	18	20	SBT-32100MD
		12	60	107	22	25	SBT-12060ME
		16	67	113	22	25	SBT-16067ME
		19	74	119	22	25	SBT-19074ME
		25	89	130	22	25	SBT-25089ME
		32	100	141	22	25	SBT-32100ME

Adapters

D_1	Style 1	Style 2	Style 3	Style 4	
i	0.500	-	BTH-05001000	BTH-05000750	-
m	10	BTH-10M12M	BTH-10M25M	BTH-10M20M	-
	12	-	BTH-12M25M	BTH-12M20M	-
	20	-	-	BTH-20M25M	-

For complete adapter details, see page B20: 25

i = Imperial (in)
m = Metric (mm)

Criterion Boring Bars

TA Insert | Imperial

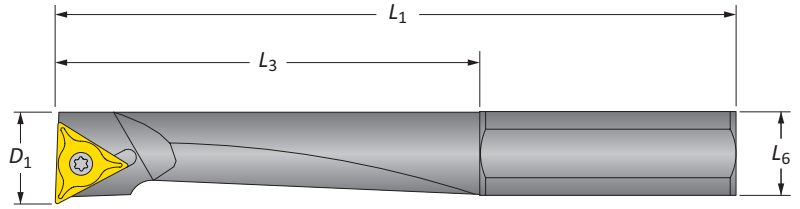
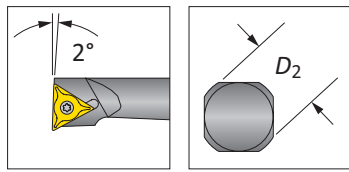

D ₁	Boring Bars				Part No.	Insert		
	L ₃	L ₁	L ₆	D ₂		IC	T ₁	Style
0.250	1.062	2.437	0.310	0.375	TA-02501062A	0.156	0.063	△ WCMT
0.312	1.437	2.750	0.310	0.375	TA-03121437A	0.156	0.078	△ TC
0.375	1.750	3.062	0.310	0.375	TA-03751750A	0.156	0.078	△ TC
0.250	1.062	2.437	0.437	0.500	TA-02501062B	0.156	0.063	△ WCMT
0.312	1.437	2.750	0.437	0.500	TA-03121437B	0.156	0.078	△ TC
0.375	1.750	3.062	0.437	0.500	TA-03751750B	0.156	0.078	△ TC
0.437	2.062	3.375	0.437	0.500	TA-04372062B	0.250	0.094	△ TP
0.500	2.187	3.500	0.437	0.500	TA-05002187B	0.250	0.094	△ TP
0.375	1.750	3.062	0.531	0.625	TA-03751750C	0.156	0.078	△ TC
0.500	2.187	3.500	0.531	0.625	TA-05002187C	0.250	0.094	△ TP
0.625	2.750	4.390	0.531	0.625	TA-06252750C	0.250	0.094	△ TP
0.500	2.500	4.250	0.641	0.750	TA-05002500D	0.250	0.094	△ TP
0.750	3.000	4.687	0.641	0.750	TA-07503000D	0.375	0.125	△ TP
1.000	3.500	5.125	0.641	0.750	TA-10003500D	0.375	0.125	△ TP
1.250	4.000	5.562	0.641	0.750	TA-12504000D	0.375	0.125	△ TP
0.500	2.375	4.250	0.859	1.000	TA-05002375E	0.250	0.094	△ TP
0.750	2.875	4.687	0.859	1.000	TA-07502875E	0.375	0.125	△ TP
1.000	3.500	5.125	0.859	1.000	TA-10003500E	0.375	0.125	△ TP
1.250	3.875	5.562	0.859	1.000	TA-12503875E	0.375	0.125	△ TP

Adapters

D ₁	Style 1	Style 2	Style 3	Style 4
0.375	BTH-03750500	BTH-03750750	-	-
0.375	-	BTH-03751000	-	-
0.500	-	BTH-05001000	BTH-05000750	-
0.750	-	-	BTH-07501000	-

For complete adapter details, see page B20: 25

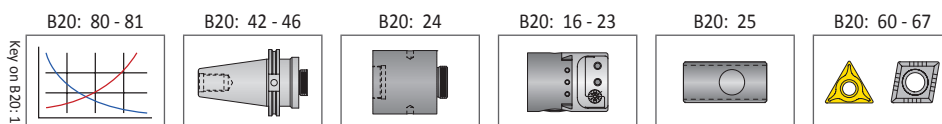

i = Imperial (in)
m = Metric (mm)
 Inserts sold separately



Criterion Boring Bars

TA Insert | Metric

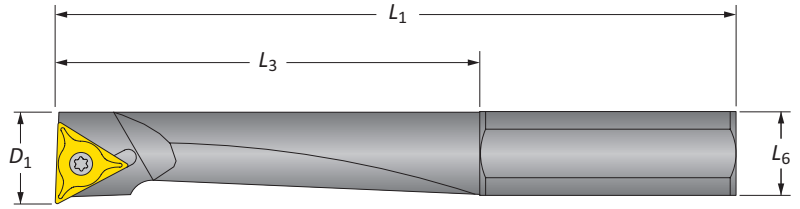
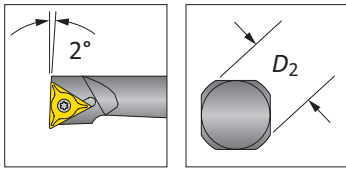

D ₁	Boring Bars				D ₂	Part No.	IC	Insert	
	L ₃	L ₁	L ₆	T ₁				Style	
6	12	47	8	10	TAS-06M012A	3.97	1.60	△ WCMT	
6	27	62	8	10	TA-06M027A	3.97	1.60	△ WCMT	
8	16	50	8	10	TAS-08M016A	3.97	1.98	△ TC	
8	36	70	8	10	TA-08M036A	3.97	1.98	△ TC	
10	20	54	8	10	TAS-10M020A	3.97	1.98	△ TC	
10	45	78	8	10	TA-10M045A	3.97	1.98	△ TC	
6	12	47	10	12	TAS-06M012B	3.97	1.60	△ WCMT	
6	27	63	10	12	TA-06M027B	3.97	1.60	△ WCMT	
8	16	50	10	12	TAS-08M016B	3.97	1.98	△ TC	
8	36	71	10	12	TA-08M036B	3.97	1.98	△ TC	
10	20	54	10	12	TAS-10M020B	3.97	1.98	△ TC	
10	45	80	10	12	TA-10M045B	3.97	1.98	△ TC	
12	24	57	10	12	TAS-12M024B	6.35	2.38	△ TC	
12	54	86	10	12	TA-12M054B	6.35	2.38	△ TC	
10	20	67	18	20	TAS-10M020D	3.97	1.98	△ TC	
10	45	92	18	20	TA-10M045D	3.97	1.98	△ TC	
12	24	70	18	20	TAS-12M024D	6.35	2.38	△ TC	
12	54	100	18	20	TA-12M054D	6.35	2.38	△ TC	
16	32	76	18	20	TAS-16M032D	9.53	3.96	△ TC	
16	72	116	18	20	TA-16M072D	6.35	2.38	△ TC	
20	40	82	18	20	TAS-20M040D	6.35	2.38	△ TC	
20	90	131	18	20	TA-20M090D	9.53	3.96	△ TC	
10	20	69	23	25	TAS-10M020E	3.97	1.98	△ TC	
10	45	94	23	25	TA-10M045E	3.97	1.98	△ TC	
12	24	73	23	25	TAS-12M024E	6.35	2.38	△ TC	
12	54	102	23	25	TA-12M054E	6.35	2.38	△ TC	
16	32	78	23	25	TAS-16M032E	9.53	3.96	△ TC	
16	72	118	23	25	TA-16M072E	9.53	3.96	△ TC	
20	40	85	23	25	TAS-20M040E	9.53	3.96	△ TC	
20	90	135	23	25	TA-20M090E	9.53	3.96	△ TC	
25	50	92	23	25	TAS-25M050E	9.53	3.96	△ TC	
25	113	155	23	25	TA-25M113E	9.53	3.96	△ TC	

Adapters

D ₁	Style 1	Style 2	Style 3	Style 4
10	BTH-10M12M	BTH-10M25M	BTH-10M20M	-
12	-	BTH-12M25M	BTH-12M20M	-
20	-	-	BTH-20M25M	-

For complete adapter details, see page B20: 25

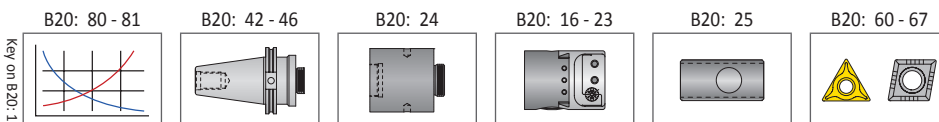

ⓘ = Imperial (in)
 ⓘ = Metric (mm)
 Inserts sold separately

Criterion Boring Bars

Steel CFX / TFX

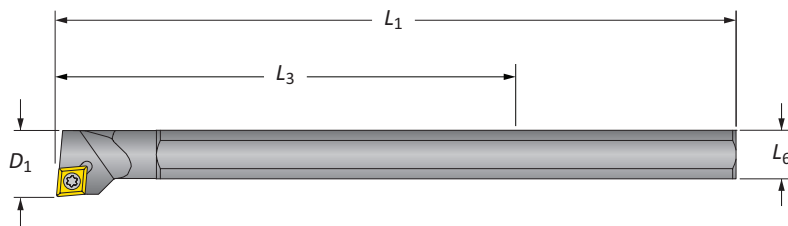
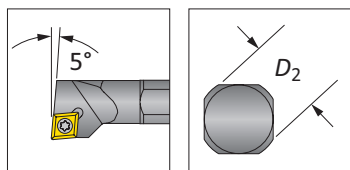

Steel CFX

i	Boring Bar					Part No.	Insert		
	D ₁	L ₃	L ₁	L ₆	D ₂		IC	T ₁	Style
	0.75	2.500	6.00	0.43	0.500	CFX-0500	0.250	0.094	◇ CP or CC
	1.00	4.000	8.00	0.66	0.750	CFX-0750	0.375	0.156	◇ CP or CC
	1.38	5.000	10.00	0.88	1.000	CFX-1000	0.375	0.156	◇ CP or CC
	1.76	6.750	10.60	1.31	1.500	CFX-1500	0.500	0.188	◇ CC

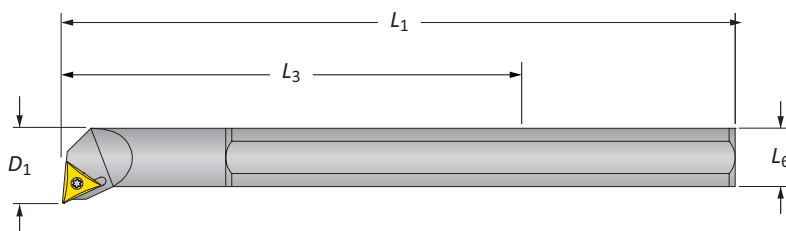
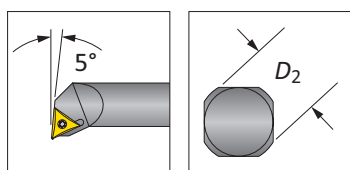

Steel TFX

i	Boring Bar					Part No.	Insert		
	D ₁	L ₃	L ₁	L ₆	D ₂		IC	T ₁	Style
	0.75	2.500	6.00	0.43	0.500	TFX-0500	0.250	0.094	△ TP
	1.00	4.000	8.00	0.66	0.750	TFX-0750	0.375	0.125	△ TP
	1.38	5.000	10.00	0.88	1.000	TFX-1000	0.375	0.125	△ TP

Adapters

i	D ₁	Style 1	Style 2	Style 3	Style 4
		0.500	-	BTH-05001000	BTH-05000750
	0.750	-	-	BTH-07501000	-
	1.000	-	-	BTH-10001500	-

For complete adapter details, see page B20: 25

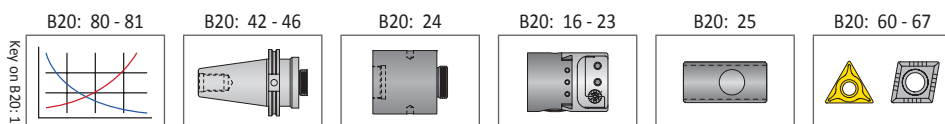

i = Imperial (in)
m = Metric (mm)
Inserts sold separately



Criterion Boring Bars

Heavy Metal CFX / TFX

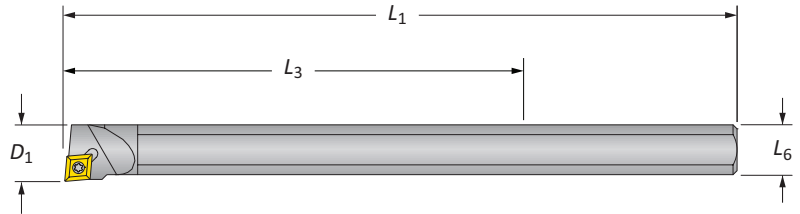
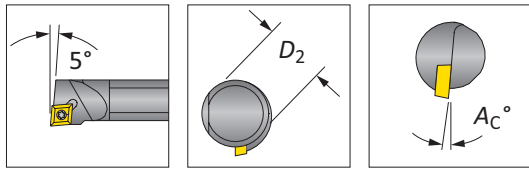

Heavy Metal CFX

D ₁ Range	Boring Bar					Part No.	Insert		
	L ₃	Angle	L ₁	L ₆	D ₂		IC	T ₁	Style
0.197 - 1.500	1.500	0°	3.00	0.180	0.187	CFX-0187HM	0.156	0.040	◇ CD
0.260 - 1.500	1.500	0°	3.00	0.230	0.250	CFX-0250HM	0.156	0.040	◇ CD
0.365 - 2.250	2.250	10°	4.00	0.290	0.312	CFX-0312HM	0.250	0.094	◇ CP or CC
0.425 - 2.250	2.250	10°	4.00	0.340	0.375	CFX-0375HM	0.250	0.094	◇ CP or CC
0.550 - 3.250	3.250	5°	6.00	0.455	0.500	CFX-0500HM	0.250	0.094	◇ CP or CC
0.688 - 4.250	4.250	8°	8.00	0.565	0.625	CFX-0625HM	0.375	0.156	◇ CP or CC
0.832 - 4.250	4.750	8°	10.00	0.680	0.750	CFX-0750HM	0.375	0.156	◇ CP or CC

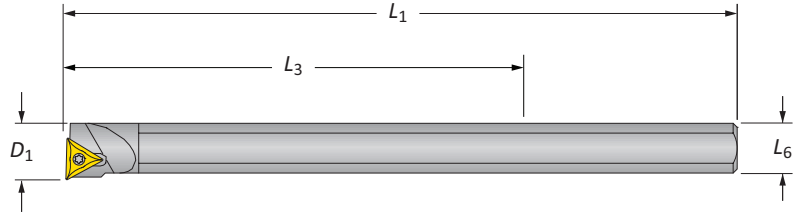
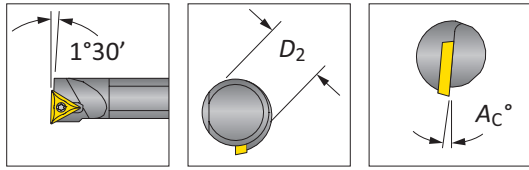

Heavy Metal TFX

D ₁ Range	Boring Bar					Part No.	Insert		
	L ₃	Angle	L ₁	L ₆	D ₂		IC	T ₁	Style
0.425 - 2.250	2.250	8°	4.00	0.340	0.375	TFX-0375HM	0.219	0.094	△ TC
0.550 - 3.250	3.250	5°	6.00	0.455	0.500	TFX-0500HM	0.250	0.094	△ TC

Adapters

D ₁	Style 1	Style 2	Style 3	Style 4
0.187	BTH-01870375	-	-	-
0.187	BTH-01870500	-	-	-
0.250	BTH-02500375	-	-	BTH-02500625
0.250	BTH-02500500	-	-	BTH-02500750
0.250	BTH-02500625	-	-	-
0.312	BTH-03120375	-	-	-
0.312	BTH-03120500	-	-	-
0.375	BTH-03750500	BTH-03750750	-	-
0.375	-	BTH-03751000	-	-
0.500	-	BTH-05001000	BTH-05000750	-
0.625	BTH-06250750	-	BTH-06251000	-
0.750	-	-	BTH-07501000	-

For complete adapter details, see page B20: 25

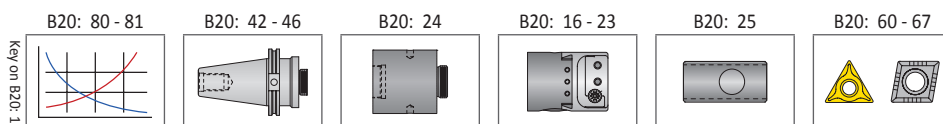

ⓘ = Imperial (in)
 ⓘ = Metric (mm)
 Inserts sold separately

Criterion Boring Bars

Carbide Shank CFX / TFX

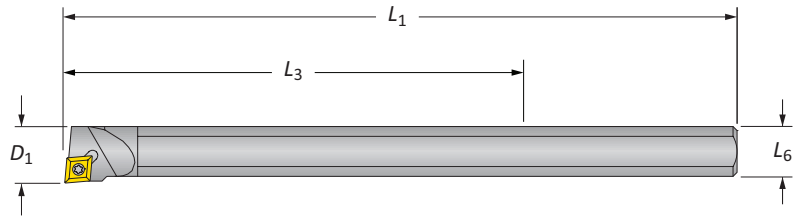
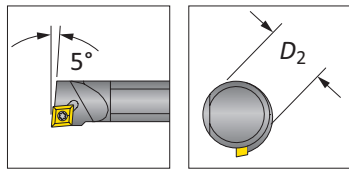

Carbide CFX

i	D ₁		Boring Bar				Part No.	Insert		
	CP Insert	CC Insert	L ₃	L ₁	L ₆	D ₂		IC	T ₁	Style
	0.500 - 3.000	0.750	3.000	6.00	0.34	0.375	CFX-0375CS	0.250	0.094	◇ CP or CC
	0.625 - 4.500	0.750	4.500	8.00	0.47	0.500	CFX-0500CS	0.250	0.094	◇ CP or CC
	0.750 - 5.500	0.750	5.500	10.00	0.59	0.625	CFX-0625CS	0.250	0.094	◇ CP or CC
	0.875 - 6.000	1.230	6.000	10.00	0.70	0.750	CFX-0750CS	0.375	0.156	◇ CP or CC

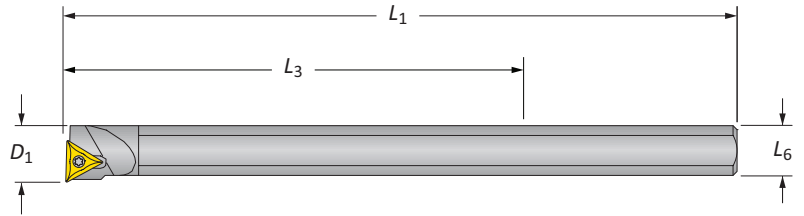
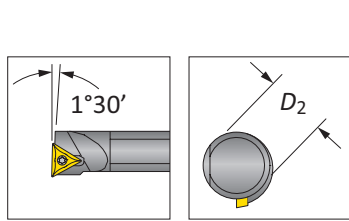

Carbide TFX

i	D ₁		Boring Bar				Part No.	Insert		
		L ₃	L ₁	L ₆	D ₂	IC		T ₁	Style	
	0.500 - 3.000	3.000	6.00	0.34	0.375	TFX-0375CS	0.250	0.094	△ TP	
	0.625 - 4.500	4.500	8.00	0.47	0.500	TFX-0500CS	0.250	0.094	△ TP	
	0.750 - 5.500	5.500	10.00	0.59	0.625	TFX-0625CS	0.375	0.125	△ TP	
	0.875 - 6.000	6.000	10.00	0.70	0.750	TFX-0750CS	0.375	0.125	△ TP	

Adapters

i	D ₁	Style 1	Style 2	Style 3	Style 4
		0.375	BTH-03750500	BTH-03750750	-
	0.375	-	BTH-03751000	-	-
	0.500	-	BTH-05001000	BTH-05000750	-
	0.625	BTH-06250750	-	BTH-06251000	-
	0.750	-	-	BTH-07501000	-

For complete adapter details, see page B20: 25

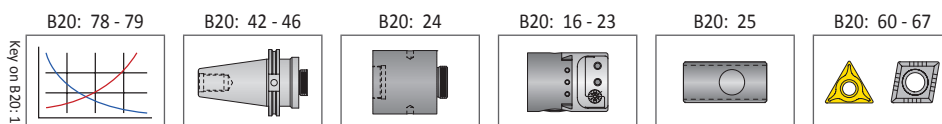

i = Imperial (in)
m = Metric (mm)
Inserts sold separately



Criterion Boring Bars

Cross Hole

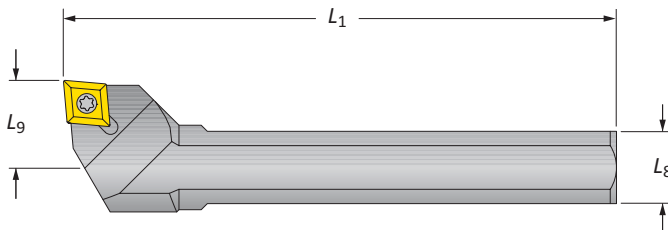
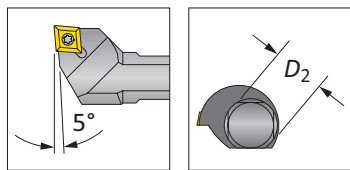

	Boring Bar					Part No.	Insert		
	D_1	L_9	L_1	L_8	D_2		IC	T_1	Style
i	2.875 - 6.687*	0.53	2.75	0.43	0.500	CHB-0500	0.250	0.094	◇ CP or CC
	4.937 - 11.000*	0.77	4.75	0.64	0.750	CHB-0750	0.375	0.156	◇ CP or CC
	5.625 - 13.437*	0.87	5.31	0.85	1.000	CHB-1000	0.375	0.156	◇ CP or CC
	9.093 - 21.500*	1.17	9.00	1.31	1.500	CHB-1500	0.500	0.188	◇ CC
m	73.00 - 169.00*	13	72	10	12	CHB-012M	6.35	2.39	◇ CP or CC
	126.00 - 279.00*	19	123	18	20	CHB-020M	9.53	3.97	◇ CP or CC
	143.00 - 341.00*	22	134	23	25	CHB-025M	9.53	3.97	◇ CP or CC

*NOTICE: Cross hole bars should always be secured in the bar holder with at least two set screws

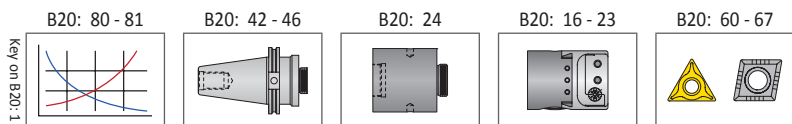

i = Imperial (in)
 m = Metric (mm)
 Inserts sold separately

Criterion Boring Inserts Nomenclature

Criterion Boring Inserts

TCMT18150	T	MF	P02
1	2	3	4



80° Rhombic









60° Triangle







80° Trigon

1. Standard ANSI / ISO Designation			2. Material	3. Chipbreaker		4. Coating
Rhombic	Triangle	Trigon	C = Carbide	FA	MB	Blank = Uncoated
CDCD	TCMT	WCMT	T = Cermet	FB	MC	T = TiN
CCET	TPGT		B = CBN	FC	MD	C01 = CVD
CCGT	TPMT			FD	ME	C02 = CVD
CCMT	TPGW			FE	MF	C03 = CVD
CCGW				FG		C04 = CVD
CCMW						P01 = PVD
CPMT						P02 = PVD

80° Rhombic

Insert Geometry	Designed for / Notes
 FB	Finishing applications • Light to medium depths of cut • Low feed rates
 FC	Chip control in finishing applications • Varied depths of cut • Low feed rates • Low cutting forces
 FD	Finishing applications • Non-ferrous metals • Large rake angle provides smooth chip flow with less adhesion for a good surface finish
 MB	Medium to finishing applications • Wide breaker dot and pocket
 MD	Medium and finishing applications • Non-ferrous metals • Positive chip groove and polished surface reduces chip adhesion
 ME	Medium and finishing applications • Stainless steel and heat-resistant alloys • Large rake angle and circular edge give good chip control

80° Triangle

Insert Geometry	Designed for / Notes
 FA	Finishing applications • Light depths of cut • Low feed rates
 FE	Finishing applications • Low carbon materials • Sticky materials
 FG	Finishing applications • Ferrous materials with good chip control
 MC	Medium and finishing applications • Cast iron
 MF	Medium general purpose applications

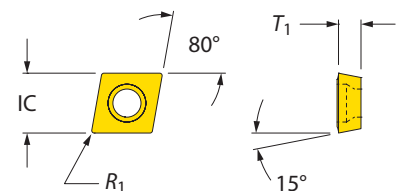

ISO Application Areas

P Steel	N Non-ferrous
M Stainless steel	S Heat resistant
K Cast iron	H Hard materials

Recommendation Key

	Recommended
	Secondary

Reference Key

Symbol	Attribute
IC	Inscribed circle
R₁	Nose radius
T₁	Insert thickness

Criterion Inserts

80° Rhombic | CD•• | CP••

CD••

Imperial (in)			Metric (mm)			Part No.
IC	T ₁	R ₁	IC	T ₁	R ₁	
0.156	0.040	0.002	3.97	1.02	0.05	CDCD513002...
0.156	0.040	0.007	3.97	1.02	0.18	CDCD513007...

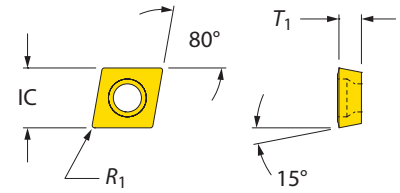

	Part No.	ISO Description	Carbide		Cermet		CBN	P		M	K	N	S	H	Torx Screw	Torx Wrench
			Uncoated	Coated	Uncoated	Coated		Free Cutting	Carbon / Alloy	Stainless	Grey Cast Iron	Nodular Cast Iron	Non-ferrous	Heat Resistant		
CDCD	CDCD513002C2	-	•							◆	◆	◆			TXS-001-1	8T-6
	CDCD513002C2T	-		•						◆		◆			TXS-001-1	8T-6
	CDCD513002C6	-	•					◆	◆						TXS-001-1	8T-6
	CDCD513007C2T	-		•						◆	◆	◆			TXS-001-1	8T-6
	CDCD513007C26T	-		•					◆	◆					TXS-001-1	8T-6

CP••

Imperial (in)			Metric (mm)			Part No.
IC	T ₁	R ₁	IC	T ₁	R ₁	
0.250	0.094	0.008	6.35	2.38	0.20	CP••2150...
0.250	0.094	0.016	6.35	2.38	0.40	CP••2151...
0.375	0.156	0.016	9.53	3.97	0.40	CP••3251...
0.375	0.156	0.031	9.53	3.97	0.80	CP••3252...

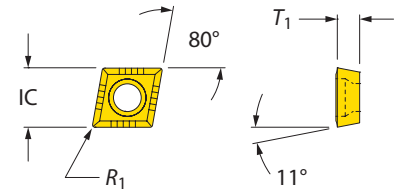

	Part No.	ISO Description	Carbide		Cermet		CBN	P		M	K	N	S	H	Torx Screw	Torx Wrench
			Uncoated	Coated	Uncoated	Coated		Free Cutting	Carbon / Alloy	Stainless	Grey Cast Iron	Nodular Cast Iron	Non-ferrous	Heat Resistant		
CPMT	CPMT2150C2T	060202		•							◆	◆			TXS-116-1	8T-7
	CPMT2150C6T	060202		•				◆	◆						TXS-116-1	8T-7
	CPMT2151C2T	060204		•							◆	◆			TXS-116-1	8T-7
	CPMT2151C6T	060204		•							◆	◆			TXS-116-1	8T-7
	CPMT3251C2T	09T304			•						◆	◆			TXS-009-1	8T-15
	CPMT3251C6T	09T304			•						◆	◆			TXS-009-1	8T-15
	CPMT3252C6T	09T308			•						◆	◆			TXS-009-1	8T-15

Key on B20-1

B20: 78 - 81

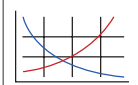

B20: 8 - 33

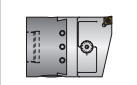

B20: 47 - 59

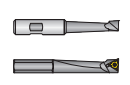

◆ = Recommended
 ✦ = Secondary

Inserts supplied in packs of 10
 Screws sold in multiples of 10

A DRILLING
 B BORING
 C REAMING
 D BURNISHING
 E THREADING
 X SPECIALS

Criterion Inserts

80° Rhombic | CC••

CC••

Imperial (in)			Metric (mm)			Part No.
IC	T ₁	R ₁	IC	T ₁	R ₁	
0.250	0.094	0.004	6.35	2.38	0.10	CC••21502
0.250	0.094	0.008	6.35	2.38	0.20	CC••21505
0.250	0.094	0.016	6.35	2.38	0.40	CC••2151
0.250	0.094	0.031	6.35	2.38	0.80	CC••2152
0.375	0.156	0.008	9.53	3.97	0.20	CC••32505
0.375	0.156	0.016	9.53	3.97	0.40	CC••3251
0.375	0.156	0.031	9.53	3.97	0.80	CC••3252
0.500	0.188	0.016	12.70	4.76	0.40	CC••431
0.500	0.188	0.031	12.70	4.76	0.80	CC••432

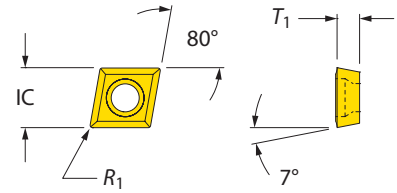

Part No.	ISO Description	Carbide		Cermets		CBN	P	M	K	N	S	H	Torx Screw	Torx Wrench
		Uncoated	Coated	Uncoated	Coated		Free Cutting	Carbon / Alloy	Stainless	Grey Cast Iron	Nodular Cast Iron	Non-ferrous		
CCET														
CCET21502CFBP01	060201		•				◆	◆	✦				TXS-116-1	8T-7
CCET21505CFCP01	060202		•				◆	◆	✦				TXS-116-1	8T-7
CCET21505TMB	060202			•			◆	◆					TXS-116-1	8T-7
CCET32505TFC	09T302			•			◆	◆					TXS-009-1	8T-15
CCGT														
CCGT32505CFD	09T302	•							✦	◆	◆		TXS-009-1	8T-15
CCGT3251CFD	09T304	•							✦	◆	◆		TXS-009-1	8T-15
CCGT3251CMD	09T304	•							✦	◆	◆		TXS-009-1	8T-15
CCGT3252CFD	09T308	•							✦	◆	◆		TXS-009-1	8T-15
CCGT3252CMD	09T308	•							✦	◆	◆		TXS-009-1	8T-15
CCGW														
CCGW21505CMC	060202	•							◆	◆	✦	✦	TXS-116-1	8T-7
CCGW3251CMC	09T304	•							◆	◆	✦	✦	TXS-009-1	8T-15
CCMW														
CCMW2151B1	060204				•			◆				◆	TXS-116-1	8T-7
CCMW2151B2	060204				•			◆	◆				TXS-116-1	8T-7
CCMW2152B1	060208				•			◆				◆	TXS-116-1	8T-7
CCMW2152B2	060208				•			◆	◆				TXS-116-1	8T-7
CCMW3251B1	09T304				•			◆				◆	TXS-009-1	8T-15
CCMW3251B2	09T304				•			◆	◆				TXS-009-1	8T-15
CCMW3252B1	09T308				•			◆				◆	TXS-009-1	8T-15
CCMW3252B2	09T308				•			◆	◆				TXS-009-1	8T-15

B20: 78 - 81

B20: 8 - 33

B20: 47 - 59

key on B20: 1

◆ = Recommended
✦ = Secondary

Inserts supplied in packs of 10
Screws sold in multiples of 10



Criterion Inserts

80° Rhombic | CC••

CC••

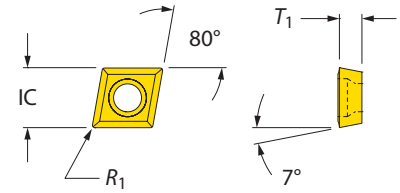
Imperial (in)			Metric (mm)			Part No.
IC	T ₁	R ₁	IC	T ₁	R ₁	
0.250	0.094	0.004	6.35	2.38	0.10	CC••21502
0.250	0.094	0.008	6.35	2.38	0.20	CC••21505
0.250	0.094	0.016	6.35	2.38	0.40	CC••2151
0.250	0.094	0.031	6.35	2.38	0.80	CC••2152
0.375	0.156	0.008	9.53	3.97	0.20	CC••32505
0.375	0.156	0.016	9.53	3.97	0.40	CC••3251
0.375	0.156	0.031	9.53	3.97	0.80	CC••3252
0.500	0.188	0.016	12.70	4.76	0.40	CC••431
0.500	0.188	0.031	12.70	4.76	0.80	CC••432



	Part No.	ISO Description	Carbide		Cermet		CBN	P		M	K	N	S	H		
			Uncoated	Coated	Uncoated	Coated		Free Cutting	Carbon / Alloy	Stainless	Grey Cast Iron	Nodular Cast Iron	Non-ferrous	Heat Resistant		
CCMT	CCMT21505CMB01	060202		•				✧	✧		✧	✧			TXS-116-1	8T-7
	CCMT21505CMBP01	060202		•							✧	✧			TXS-116-1	8T-7
	CCMT21505TMB	060202			•			✧	✧						TXS-116-1	8T-7
	CCMT2150C2	060202		•							✧	✧	✧		TXS-116-1	8T-7
	CCMT2150C2T	060202			•						✧	✧	✧		TXS-116-1	8T-7
	CCMT2150C6	060202		•				✧	✧						TXS-116-1	8T-7
	CCMT2150C6T	060202			•			✧	✧						TXS-116-1	8T-7
	CCMT2151C2	060204		•								✧	✧	✧	TXS-116-1	8T-7
	CCMT2151C2T	060204			•							✧	✧	✧	TXS-116-1	8T-7
	CCMT2151C6	060204		•				✧	✧						TXS-116-1	8T-7
	CCMT2151C6T	060204			•			✧	✧						TXS-116-1	8T-7
	CCMT32505TMB	09T302				•		✧	✧						TXS-009-1	8T-15
	CCMT3250C2	09T302		•								✧	✧		TXS-009-1	8T-15
	CCMT3250C2T	09T302			•							✧	✧		TXS-009-1	8T-15
	CCMT3250C6	09T302		•				✧	✧						TXS-009-1	8T-15
	CCMT3250C6T	09T302			•			✧	✧						TXS-009-1	8T-15
	CCMT3251TMB	09T304				•		✧	✧						TXS-009-1	8T-15
	CCMT3251CMEC02	09T304			•					✧				✧	TXS-009-1	8T-15
	CCMT3251C2	09T304		•								✧	✧	✧	TXS-009-1	8T-15
	CCMT3251C2T	09T304			•							✧	✧	✧	TXS-009-1	8T-15
	CCMT3251C6	09T304		•				✧	✧						TXS-009-1	8T-15
	CCMT3251C6T	09T304			•			✧	✧						TXS-009-1	8T-15
	CCMT3252CMEC02	09T308			•					✧				✧	TXS-009-1	8T-15
	CCMT3252C2	09T308		•								✧	✧	✧	TXS-009-1	8T-15
	CCMT3252C2T	09T308			•							✧	✧	✧	TXS-009-1	8T-15
	CCMT3252C6	09T308		•				✧	✧						TXS-009-1	8T-15
	CCMT3252C6T	09T308			•			✧	✧						TXS-009-1	8T-15
	CCMT431CMB01	120404			•			✧	✧						TXS-119-1	8T-15
	CCMT432C6T	120408			•			✧	✧						TXS-119-1	8T-15

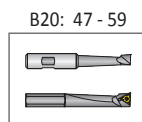
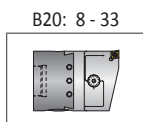
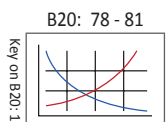

✧ = Recommended
✧ = Secondary

Inserts supplied in packs of 10
Screws sold in multiples of 10

A DRILLING
B BORING
C REAMING
D BURNISHING
E THREADING
X SPECIALS

Criterion Inserts

60° Triangle | TC••

TC••

Imperial (in)			Metric (mm)			Part No.
IC	T ₁	R ₁	IC	T ₁	R ₁	
0.156	0.078	0.016	3.97	1.98	0.40	TC••12121...
0.156	0.078	0.031	3.97	1.98	0.80	TC••12122...
0.219	0.094	0.008	5.56	2.38	0.20	TC••18150...
0.219	0.094	0.016	5.56	2.38	0.40	TC••18151...
0.250	0.094	0.008	6.35	2.38	0.20	TC••2150...
0.250	0.094	0.008	6.35	2.38	0.20	TC••21505...
0.250	0.094	0.016	6.35	2.38	0.40	TC••2151...
0.375	0.156	0.016	9.53	3.97	0.40	TC••3251...

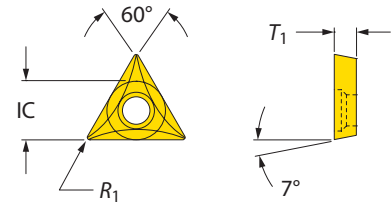

Part No.	ISO Description	Carbide		Cermet		CBN	P		M	K	N	S	H	Torx Screw	Torx Wrench
		Uncoated	Coated	Uncoated	Coated		Free Cutting	Carbon / Alloy	Stainless	Grey Cast Iron	Nodular Cast Iron	Non-ferrous	Heat Resistant		
TCMT12121C2	06T104	•								◆	◆			TXS-028-1	8T-6
TCMT12121C2T	06T104		•							◆	◆	❖		TXS-028-1	8T-6
TCMT12121C6T	06T104		•				◆	◆						TXS-028-1	8T-6
TCMT12121CFGC04	06T104		•				◆	◆						TXS-028-1	8T-6
TCMT12122C2	06T108	•								◆	◆	❖		TXS-028-1	8T-6
TCMT12122C2T	06T108		•				◆	◆		◆	◆	❖		TXS-028-1	8T-6
TCMT12122C6T	06T108		•											TXS-028-1	8T-6
TCMT18150C2	090202	•								◆	◆	❖		TXS-116-1	8T-7
TCMT18150C2T	090202		•				◆	◆		◆	◆	❖		TXS-116-1	8T-7
TCMT18150C6	090202	•					◆	◆						TXS-116-1	8T-7
TCMT18150C6T	090202		•											TXS-116-1	8T-7
TCMT18150TMF	090202			•			◆	◆						TXS-116-1	8T-7
TCMT18150TMFP02	090202				•		❖	❖		◆				TXS-116-1	8T-7
TCMT18151TMF	090204			•			◆	◆						TXS-116-1	8T-7
TCMT18151TMFP02	090204				•		❖	❖		◆				TXS-116-1	8T-7
TCMT2150C2	110202	•								◆	◆	❖		TXS-116-1	8T-7
TCMT2150C2T	110202		•							◆	◆	❖		TXS-116-1	8T-7
TCMT2150C6	110202	•					◆	◆						TXS-116-1	8T-7
TCMT2150C6T	110202		•				◆	◆						TXS-116-1	8T-7
TCMT21505TMF	110202			•			◆	◆						TXS-116-1	8T-7
TCMT21505TMFP02	110202				•		❖	❖		◆				TXS-116-1	8T-7
TCMT2151TMF	110204			•			◆	◆						TXS-116-1	8T-7
TCMT2151TMFP02	110204				•		❖	❖		◆				TXS-116-1	8T-7
TCMT3251C6	16T304	•					◆	◆						TXS-100-1	8T-20
TCMT3251C6T	16T304		•				◆	◆						TXS-100-1	8T-20

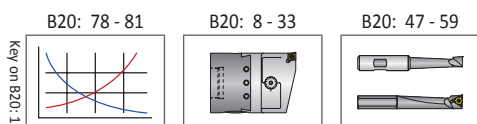

◆ = Recommended
❖ = Secondary

Inserts supplied in packs of 10
Screws sold in multiples of 10

Criterion Inserts

60° Triangle | TP••

TP••

Imperial (in)			Metric (mm)			Part No.
IC	T ₁	R ₁	IC	T ₁	R ₁	
0.250	0.094	0.002	6.35	2.38	0.05	TP••2150...
0.250	0.094	0.016	6.35	2.38	0.40	TP••2151...
0.250	0.094	0.031	6.35	2.38	0.80	TP••2152...
0.375	0.125	0.008	9.53	3.18	0.40	TP••3205
0.375	0.125	0.016	9.53	3.18	0.40	TP••321...
0.375	0.125	0.031	9.53	3.18	0.80	TP••322...
0.375	0.156	0.016	9.53	3.97	0.40	TP••3251...
0.375	0.156	0.031	9.53	3.97	0.80	TP••3252...

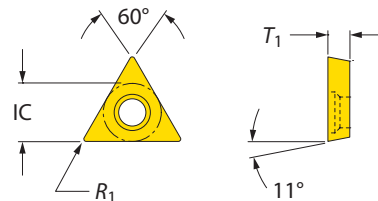

	Part No.	ISO Description	Carbide		Cermet		CBN	P	M	K	N	S	H	Torx Screw	Torx Wrench	
			Uncoated	Coated	Uncoated	Coated		Free Cutting	Carbon / Alloy	Stainless	Grey Cast Iron	Nodular Cast Iron	Non-ferrous			Heat Resistant
TPGT	TPGT2151C2	110204	•							♦	♦	✦		TXS-116-1	8T-7	
	TPGT2151C2T	110204		•						♦	♦	✦		TXS-116-1	8T-7	
	TPGT2151C6	110204	•					♦	♦					TXS-116-1	8T-7	
	TPGT2151C6T	110204		•				♦	♦					TXS-116-1	8T-7	
	TPGT2152C2	110208	•							♦	♦	✦		TXS-116-1	8T-7	
	TPGT2152C2T	110208		•						♦	♦	✦		TXS-116-1	8T-7	
	TPGT2152C6	110208	•							♦	♦			TXS-116-1	8T-7	
	TPGT2152C6T	110208		•						♦	♦			TXS-116-1	8T-7	
	TPGT321C2	160304	•								♦	♦	✦		TXS-100-1	8T-20
	TPGT321C2T	160304		•							♦	♦	✦		TXS-100-1	8T-20
	TPGT321C6	160304	•						♦	♦					TXS-100-1	8T-20
	TPGT321C6T	160304		•					♦	♦					TXS-100-1	8T-20
	TPGT322C2	160308	•								♦	♦	✦		TXS-100-1	8T-20
	TPGT322C2T	160308		•							♦	♦	✦		TXS-100-1	8T-20
	TPGT322C6	160308	•								♦	♦			TXS-100-1	8T-20
	TPGT322C6T	160308		•							♦	♦			TXS-100-1	8T-20
	TPGT3251C2	16T304	•								♦	♦	✦		TXS-100-1	8T-20
	TPGT3251C2T	16T304		•							♦	♦	✦		TXS-100-1	8T-20
	TPGT3251C6	16T304	•								♦	♦			TXS-100-1	8T-20
	TPGT3251C6T	16T304		•							♦	♦			TXS-100-1	8T-20
TPGT3252C2	16T308	•								♦	♦	✦		TXS-100-1	8T-20	
TPGT3252C2T	16T308		•							♦	♦	✦		TXS-100-1	8T-20	
TPGT3252C6	16T308	•								♦	♦			TXS-100-1	8T-20	
TPGT3252C6T	16T308		•							♦	♦			TXS-100-1	8T-20	
TPMT	TPMT3205CMFC03	160302		•								✦	✦	TXS-100-1	8T-20	
	TPMT321CMFC03	160304		•								✦	✦	TXS-100-1	8T-20	
	TPMT321CFEC03	160304		•				✦	✦			✦	✦	TXS-100-1	8T-20	
	TPMT321CFEP01	160304		•				♦	♦	✦				TXS-100-1	8T-20	
	TPMT322CFEC03	160308		•				✦	✦	♦			✦	✦	TXS-100-1	8T-20
	TPMT322CFEP01	160308		•				♦	♦	✦					TXS-100-1	8T-20

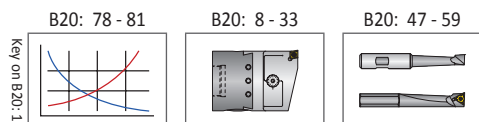

♦ = Recommended
✦ = Secondary

Inserts supplied in packs of 10
Screws sold in multiples of 10

A DRILLING
B BORING
C REAMING
D BURNISHING
E THREADING
X SPECIALS

Criterion Inserts



60° Triangle | TP••

TP••

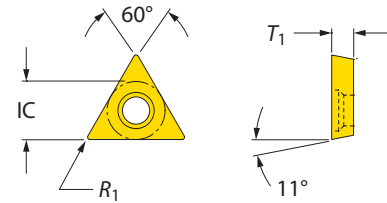
Imperial (in)			Metric (mm)			Part No.
IC	T ₁	R ₁	IC	T ₁	R ₁	
0.250	0.094	0.002	6.35	2.38	0.05	TP••2150...
0.250	0.094	0.016	6.35	2.38	0.40	TP••2151...
0.250	0.094	0.031	6.35	2.38	0.80	TP••2152...
0.375	0.125	0.016	9.53	3.18	0.40	TP••321...
0.375	0.125	0.031	9.53	3.18	0.80	TP••322...
0.375	0.156	0.016	9.53	3.97	0.40	TP••3251...
0.375	0.156	0.031	9.53	3.97	0.80	TP••3252...

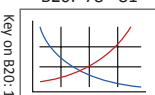

Part No.	ISO Description	Carbide		Cermet		CBN	P	M	K	N	S	H	Torx Screw	Torx Wrench
		Uncoated	Coated	Uncoated	Coated		Free Cutting	Carbon / Alloy	Stainless	Grey Cast Iron	Nodular Cast Iron	Non-ferrous		
TPGW2150C2	1102V5	•							◆	◆	◇		TXS-116-1	8T-7
TPGW2150C2T	1102V5		•						◆	◆	◇		TXS-116-1	8T-7
TPGW2150C6	1102V5	•					◆	◇					TXS-116-1	8T-7
TPGW2150C6T	1102V5		•				◆	◇					TXS-116-1	8T-7
TPGW2151C2	110204	•							◆	◆	◇		TXS-116-1	8T-7
TPGW2151C2T	110204		•						◆	◆	◇		TXS-116-1	8T-7
TPGW2151C6	110204	•					◆	◇					TXS-116-1	8T-7
TPGW2151C6T	110204		•				◆	◇					TXS-116-1	8T-7
TPGW2152C2	110208	•							◆	◆	◇		TXS-116-1	8T-7
TPGW2152C2T	110208		•						◆	◆	◇		TXS-116-1	8T-7
TPGW2152C6	110208	•					◆	◇					TXS-116-1	8T-7
TPGW2152C6T	110208		•				◆	◇					TXS-116-1	8T-7
TPGW320C2	1603V5	•							◆	◆	◇		TXS-100-1	8T-20
TPGW320C2T	1603V5		•						◆	◆	◇		TXS-100-1	8T-20
TPGW320C6	1603V5	•					◆	◇					TXS-100-1	8T-20
TPGW320C6T	1603V5		•				◆	◇					TXS-100-1	8T-20
TPGW321C2	160304	•							◆	◆	◇		TXS-100-1	8T-20
TPGW321C2T	160304		•						◆	◆	◇		TXS-100-1	8T-20
TPGW321C6	160304	•					◆	◇					TXS-100-1	8T-20
TPGW321C6T	160304		•				◆	◇					TXS-100-1	8T-20
TPGW322C2	160308	•							◆	◆	◇		TXS-100-1	8T-20
TPGW322C2T	160308		•						◆	◆	◇		TXS-100-1	8T-20
TPGW322C6	160308	•					◆	◇					TXS-100-1	8T-20
TPGW322C6T	160308		•				◆	◇					TXS-100-1	8T-20
TPGW3250C2	16T3V5	•							◆	◆	◇		TXS-100-1	8T-20
TPGW3250C2T	16T3V5		•						◆	◆	◇		TXS-100-1	8T-20
TPGW3250C6	16T3V5	•					◆	◇					TXS-100-1	8T-20
TPGW3250C6T	16T3V5		•				◆	◇					TXS-100-1	8T-20
TPGW3251C2	16T304	•							◆	◆	◇		TXS-100-1	8T-20
TPGW3251C2T	16T304		•						◆	◆	◇		TXS-100-1	8T-20
TPGW3251C6	16T304	•					◆	◇					TXS-100-1	8T-20
TPGW3251C6T	16T304		•				◆	◇					TXS-100-1	8T-20
TPGW3252C2	16T308	•							◆	◆	◇		TXS-100-1	8T-20
TPGW3252C2T	16T308		•						◆	◆	◇		TXS-100-1	8T-20
TPGW3252C6	16T308	•					◆	◇					TXS-100-1	8T-20
TPGW3252C6T	16T308		•				◆	◇					TXS-100-1	8T-20

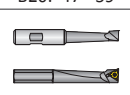
B20: 78 - 81  B20: 8 - 33  B20: 47 - 59 

key on B20: 1

◆ = Recommended
◇ = Secondary

Inserts supplied in packs of 10
Screws sold in multiples of 10

Criterion Inserts

80° Trigon | WC••

WC••

Imperial (in)			Metric (mm)			Part No.
IC	T ₁	R ₁	IC	T ₁	R ₁	
0.156	0.063	0.008	3.97	1.60	0.20	WC••020102...
0.156	0.063	0.016	3.97	1.60	0.40	WC••020104...

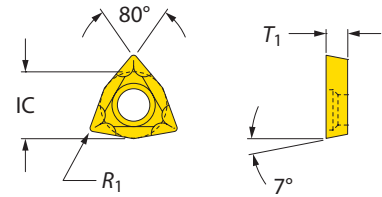

Part No.	ISO Description	Carbide		Cermet		CBN	P	M	K	N	S	H	Torx Screw	Torx Wrench
		Uncoated	Coated	Uncoated	Coated		Free Cutting	Carbon / Alloy	Stainless	Grey Cast Iron	Nodular Cast Iron	Non-ferrous		
WCMT	WCMT020102C2	020102	•					❖	❖	❖	♦		TXS-028-1	8T-6
	WCMT020102C2T	020102		•				♦	♦	♦	❖		TXS-028-1	8T-6
	WCMT020102C6	020102	•				❖	❖					TXS-028-1	8T-6
	WCMT020102C6T	020102		•			♦	♦					TXS-028-1	8T-6
	WCMT020104C2	020104	•					❖	❖	❖	♦		TXS-028-1	8T-6
	WCMT020104C2T	020104		•				♦	♦	♦	❖		TXS-028-1	8T-6
	WCMT020104C6	020104	•				❖	❖					TXS-028-1	8T-6
	WCMT020104C6T	020104		•			♦	♦					TXS-028-1	8T-6

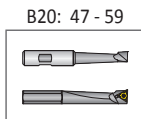
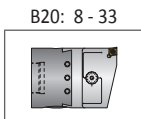
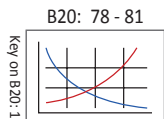

♦ = Recommended
❖ = Secondary
Inserts supplied in packs of 10
Screws sold in multiples of 10

A DRILLING
B BORING
C REAMING
D BURNISHING
E THREADING
X SPECIALS

Criterion Boring Kits

Micro Adjusting | CNC Kits

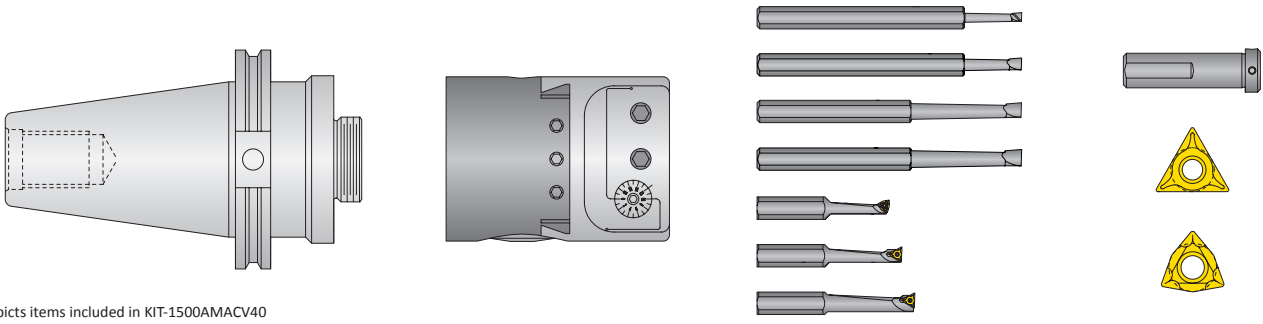

Image depicts items included in KIT-1500AMACV40

D_1 Range	Components Included in Kit					Part No.
	Boring Head	Shank	Boring Bars	Adapters	Inserts	
0.060 - 2.500	CB-1500AMA	CB1500-CV40	CBT-00600300G CBT-00800300G CBT-01000600G CBT-01100600G TA-02501062A TA-03121437A TA-03751750A	BTH-01250375	WCMT020102C6T TCMT12121CFGC04	KIT-1500AMACV40
0.060 - 2.500	CB-1500AMA	CB1500-CV50	CBT-00600300G CBT-00800300G CBT-01000600G CBT-01100600G TA-02501062A TA-03121437A TA-03751750A	BTH-01250375	WCMT020102C6T TCMT12121CFGC04	KIT-1500AMACV50
0.060 - 3.250	CB-2500BMA	CB2500-CV40	CBT-00600300G CBT-00800300G CBT-01000600G CBT-01100600G TA-02501062B TA-03121437B TA-03751750B TA-04372062B TA-05002187B	BTH-01250500	WCMT020102C6T TCMT12121CFGC04 TPGT2151C6T	KIT-2500BMACV40
0.060 - 3.250	CB-2500BMA	CB2500-CV50	CBT-00600300G CBT-00800300G CBT-01000600G CBT-01100600G TA-02501062B TA-03121437B TA-03751750B TA-04372062B TA-05002187B	BTH-01250500	WCMT020102C6T TCMT12121CFGC04 TPGT2151C6T	KIT-2500BMACV50

i

i = Imperial (in)
m = Metric (mm)

A DRILLING
B BORING
C REAMING
D BURNISHING
E THREADING
X SPECIALS



Criterion Boring Kits

Micro Adjusting | CNC Kits

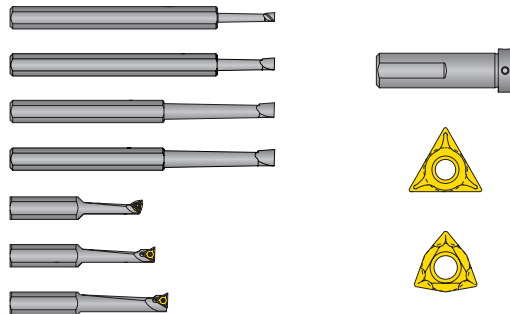
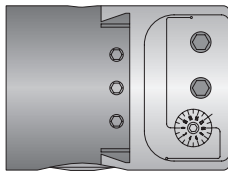
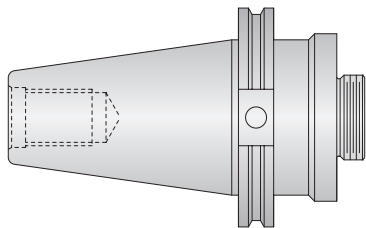

Image depicts items included in KIT-1500AMACV40

	Components Included in Kit						
	D_1 Range	Boring Head	Shank	Boring Bars	Adapters	Inserts	Part No.
	0.120 - 5.125	CB-3000DMA	CB3000-CV40	CBT-01200500H CBT-01400625H CBT-01600750H CBT-01800875H TA-02501062B TA-03121437B TA-03751750B TA-04372062B TA-05002500D TA-07503000D TA-10003500D TA-12504000D	BTH-02500750 BTH-05000750	WCMT020102C6T TCMT12121CFGC04 TPGT2151C6T TPGT321C6T	KIT-3000DMACV40
i	0.120 - 5.125	CB-3000DMA	CB3000-CV50	CBT-01200500H CBT-01400625H CBT-01600750H CBT-01800875H TA-02501062B TA-03121437B TA-03751750B TA-04372062B TA-05002500D TA-07503000D TA-10003500D TA-12504000D	BTH-02500750 BTH-05000750	WCMT020102C6T TCMT12121CFGC04 TPGT2151C6T TPGT321C6T	KIT-3000DMACV50

i = Imperial (in)
m = Metric (mm)

Criterion Boring Kits

CB Style | Balance Kits

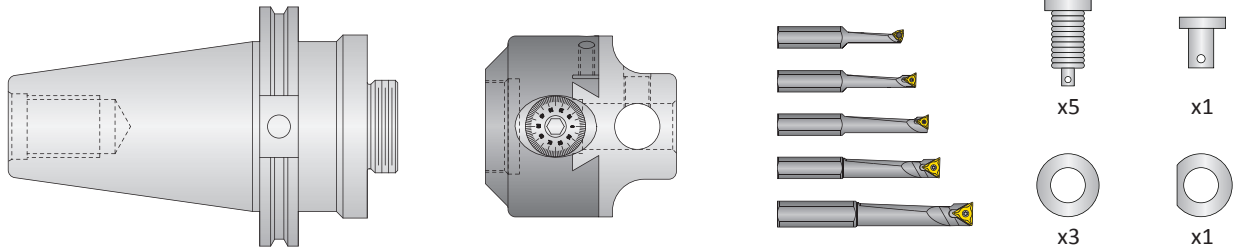
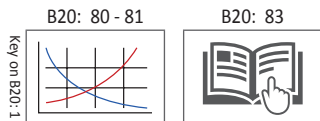

Image depicts items included in KIT-202BCV40BAL

	Components Included in Kit			Part No.	
	D ₁ Range	Boring Head	Boring Bars		
i	0.250 - 2.500	—	—	KIT-202BBAL	
	0.250 - 2.500	Kits include: • CB-202B	Kits include: • TA-02501062B	—	KIT-202BTABAL
			• TA-03121437B	R8-087520	KIT-202BR8BAL
			• TA-03751750B	NMBT40-087520	KIT-202BNT40BAL
			• TA-04372062B	CB2000-CV40	KIT-202BCV40BAL
			• TA-05002187B	CB2000-BT40	KIT-202BBT40BAL
CB2000-HSK63A	KIT-202BHS63BAL				
m	6 - 76	—	—	KIT-050MBBAL	
	6 - 76	Kits include: • CB-050MB	Kits include: • TA-06M027B	—	KIT-050MBTABAL
			• TA-08M036B	CB050M-DIN40	KIT-050MBD40BAL
		• TA-10M045B • TA-12M054B	CB050M-ISO40	KIT-050MBI40BAL	

NOTE: To obtain balance, all kits include 6 shafts and 4 weights

- Notes:**
- Bores up to 8x faster
 - Fits all 202B style boring heads
 - Improves bore finish, concentricity, and productivity
 - Simple and easy to use
 - U.S. Patent No.: 7,309,194



i = Imperial (in)
m = Metric (mm)
Inserts sold separately

A DRILLING

B BORING

C REAMING

D BURNISHING

F THREADING

X SPECIALS



Cri-Tip Boring Heads - Competitor Connection Kits

CB Style | Balance Kits

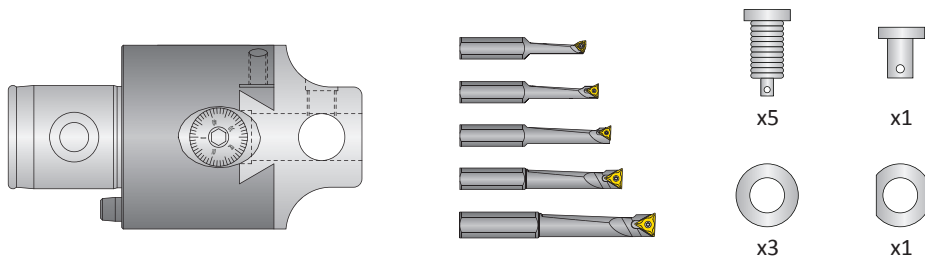

Big® Kaiser®

	Components Included in Kit			Part No.
	D ₁ Range	Boring Head	Boring Bars	
i	0.250 - 2.500	CTP2000-K5202B	TA-02501062B TA-03121437B TA-03751750B TA-04372062B TA-05002187B	KIT-CTP202K5BAL

NOTE: To obtain balance, all kits include 6 shafts and 4 weights

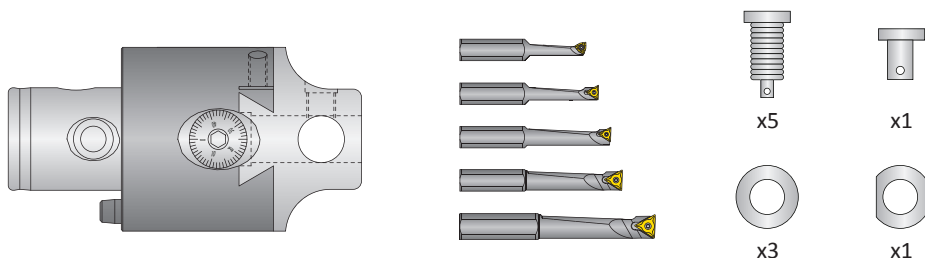

Komet® ABS®

	Components Included in Kit			Part No.
	D ₁ Range	Boring Head	Boring Bars	
i	0.250 - 2.500	CTP2000-A50202B	TA-02501062B TA-03121437B TA-03751750B TA-04372062B TA-05002187B	KIT-CTP202A5BAL

NOTE: To obtain balance, all kits include 6 shafts and 4 weights

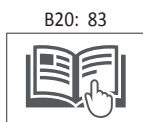
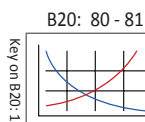

i = Imperial (in)
m = Metric (mm)
Inserts sold separately

Criterion Boring Kits

CB Style | Carbide Boring Bars

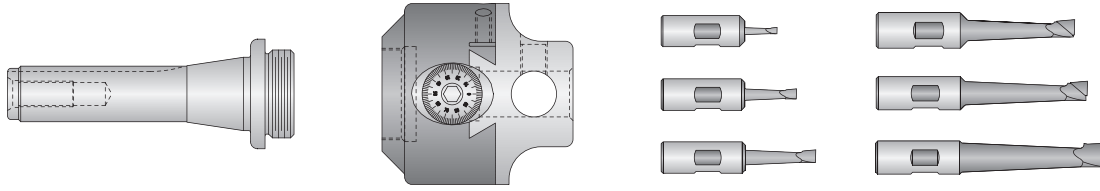
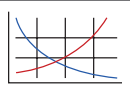



Image depicts items included in KIT-202BR8SBT

	Components Included in Kit					Part No.
	D ₁ Range	Boring Head	Shank	Boring Bars	Adapters	
	0.125 - 2.500	CB-202B	R8-087520	SBT-01250500B SBT-01870812B SBT-02501125B SBT-03121500B SBT-03751750B SBT-05002187B	-	KIT-202BR8SBT
	0.500 - 5.125	CB-203D	R8-150018	SBT-05002187D SBT-06252750D SBT-07503000D SBT-10003500D SBT-12504000D	-	KIT-203DR8SBT
i	0.125 - 5.125	CB-203D	R8-150018	SBT-01250500B SBT-01870812B SBT-02501125B SBT-03121500B SBT-03751750B SBT-05002187B SBT-06252750D SBT-07503000D SBT-10003500D SBT-12504000D	BTH-05000750	KIT-203DR8SBTBD
	3 - 62	CB-038MA	-	SBT-03012MA SBT-04020MA SBT-06028MA SBT-08037MA SBT-10048MA SBT-12055MA	-	KIT-CB038MASBT
m	0.05 - 76	CB-050MB	-	SBT-03012MB SBT-04020MB SBT-06028MB SBT-08037MB SBT-10048MB SBT-12055MB	CHB-012M	KIT-CB050MBSBT
	12 - 130	CB-076MD	-	SBT-12063MD SBT-16071MD SBT-19078MD SBT-25090MD SBT-32100MD	CHB-020M	KIT-CB076MDSBT

B20: 80 - 81  Key on B20: 1

B20: 83 

i = Imperial (in)
m = Metric (mm)

A DRILLING
B BORING
C REAMING
D BURNISHING
E THREADING
X SPECIALS



Criterion Boring Kits

CB Style | TA Insert Boring Bars

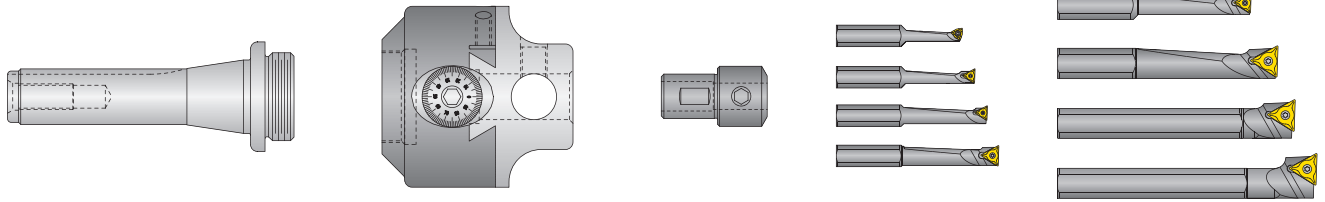
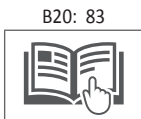
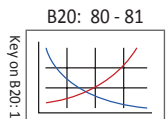

Image depicts items included in KIT-203DR8TABD

	Components Included in Kit					Part No.
	D ₁ Range	Boring Head	Shank	Boring Bars	Adapters	
	0.250 - 2.500	CB-202B	R8-087520	TA-02501062B TA-03121437B TA-03751750B TA-04372062B TA-05002187B	-	KIT-202BR8TA
	0.500 - 5.125	CB-203D	R8-150018	TA-05002500D TA-07503000D TA-10003500D TA-12504000D	-	KIT-203DR8TA
i	0.250 - 5.125	CB-203D	R8-150018	TA-02501062B TA-03121437B TA-03751750B TA-04372062B TA-05002500D TA-07503000D TA-10003500D TA-12504000D	BTH-05000750	KIT-203DR8TABD
	0.250 - 5.125	CB-203D	CB3000-CV40	TA-02501062B TA-03121437B TA-03751750B TA-04372062B TA-05002500D TA-07503000D TA-10003500D TA-12504000D	BTH-05000750	KIT-203DC40TABD
	6 - 62	CB-038MA	-	TA-06M027A TA-08M036A TA-10M045A	-	KIT-CB038MATA
	6 - 62	CB-038MA	-	TAS-06M012A TAS-08M016A TAS-10M020A	-	KIT-CB038MATAS
	6 - 76	CB-050MB	-	TA-06M027B TA-08M036B TA-10M045B TA-12M054B	CHB-012M	KIT-CB050MBTA
m	6 - 76	CB-050MB	-	TAS-06M012B TAS-08M016B TAS-10M020B TAS-12M024B	CHB-012M	KIT-CB050MBTAS
	10 - 130	CB-076MD	-	TA-10M045D TA-12M054D TA-16M072D TA-20M090D	CHB-020M	KIT-CB076MDTA
	10 - 130	CB-076MD	-	TAS-10M020D TAS-12M024D TAS-16M032D TAS-20M040D	CHB-020M	KIT-CB076MDTAS



i = Imperial (in)
m = Metric (mm)
Inserts sold separately

Criterion Boring Bar Sets

Carbide | Round Shank | Imperial

A
DRILLING

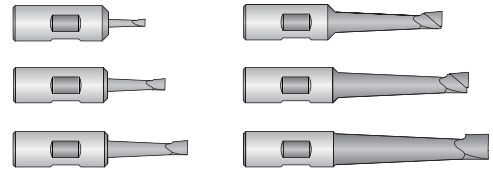

Image depicts items included in SET-SBTB

B
BORING

D_2	Boring Bars Included in Set	Part No.
0.375	SBT-01250500A SBT-01870812A SBT-02501125A SBT-03121500A SBT-03751875A SBT-05002312A	SET-SBTA
0.500	SBT-01250500B SBT-01870812B SBT-02501125B SBT-03121500B SBT-03751750B SBT-05002187B	SET-SBTB
0.750	SBT-05002187D SBT-06252750D SBT-07503000D SBT-10003500D SBT-12504000D	SET-SBTD
1.000	SBT-05002375E SBT-06252625E SBT-07502875E SBT-10003500E SBT-12503875E	SET-SBTE

C
REAMING

D
BURNISHING

F
THREADING

X
SPECIALS

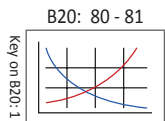

i = Imperial (in)
m = Metric (mm)



Criterion Boring Bar Sets

Carbide | Round Shank | Stubby

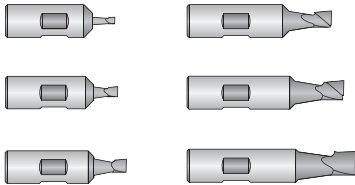
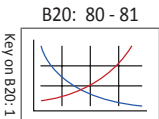

Image depicts items included in SET-SBTBSHT

	D_2	Boring Bars Included in Set	Part No.
i	0.500	SBT-01250250B SBT-01870312B SBT-02500437B SBT-03120562B SBT-03750687B SBT-05000812B	SET-SBTBSHT
	0.750	SBT-05001312D SBT-07501531D SBT-10001750D	SET-SBTDSHT



i = Imperial (in)
m = Metric (mm)

Criterion Boring Bar Sets

Carbide | Square Shank

A DRILLING

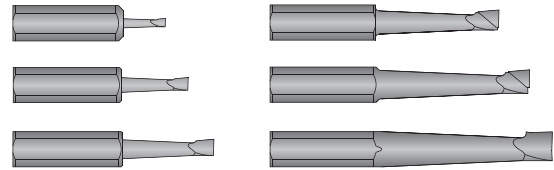

Image depicts items included in SET-SBTBS

B BORING

D_2	Boring Bars Included in Set	Part No.
i 0.500	SBT-01250500BS	SET-SBTBS
	SBT-01870812BS	
	SBT-02501125BS	
	SBT-03121500BS	
	SBT-03751750BS	
m 10	SBT-05002187BS	SET-SBTMA
	SBT-03012MA	
	SBT-04020MA	
	SBT-06028MA	
	SBT-08037MA	
m 12	SBT-10048MA	SET-SBTMB
	SBT-12055MA	
	SBT-03012MB	
	SBT-04020MB	
	SBT-06028MB	
m 20	SBT-08037MB	SET-SBTMD
	SBT-10048MB	
	SBT-12055MB	
	SBT-12063MD	
	SBT-16071MD	
m 25	SBT-19078MD	SET-SBTME
	SBT-25090MD	
	SBT-32100MD	
	SBT-12060ME	
	SBT-16067ME	
	SBT-19047ME	
	SBT-25089ME	
	SBT-32100ME	

C REAMING

D BURNISHING

F THREADING

X SPECIALS

B20: 80 - 81

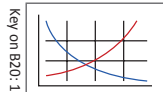

i = Imperial (in)
m = Metric (mm)



Criterion Boring Bar Sets

TA Insert

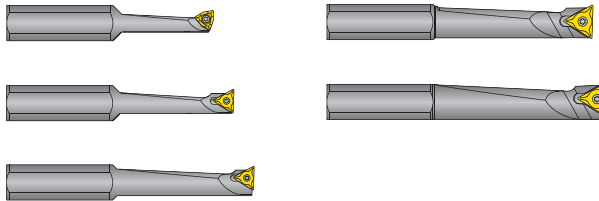
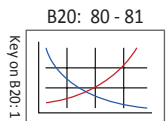

Image depicts items included in SET-TAB

	D_2	Boring Bars Included in Set	Part No.
i	0.500	TA-02501062B TA-03121437B TA-03751750B TA-04372062B TA-05002187B	SET-TAB
	0.750	TA-05002500D TA-07503000D TA-10003500D TA-12504000D	SET-TAD
	1.000	TA-05002375E TA-07502875E TA-10003500E TA-12503875E	SET-TAE
m	10	TA-06M027A TA-08M036A TA-10M045A	SET-TAMA
	10	TAS-06M012A TAS-08M016A TAS-10M020A	SET-TASMA
	12	TA-06M027B TA-08M036B TA-10M045B TA-12M054B	SET-TAMB
	12	TAS-06M012B TAS-08M016B TAS-10M020B TAS-12M024B	SET-TASMB
	20	TA-10M045D TA-12M054D TA-16M072D TA-20M090D	SET-TAMD
	20	TAS-10M020D TAS-12M024D TAS-16M032D TAS-20M040D	SET-TASMD
	25	TA-10M045E TA-12M054E TA-16M072E TA-20M090E TA-25M113E	SET-TAME
	25	TAS-10M020E TAS-12M024E TAS-16M032E TAS-20M040E TAS-25M050E	SET-TASME



i = Imperial (in)
m = Metric (mm)
Inserts sold separately

Recommended Cutting Data | Imperial (inch)

Rough Boring

ISO	Material	Hardness (BHN)	Cri-Twin®		Feed (IPR)
			SFM		
			Uncoated Inserts	Coated Inserts	
P	Free Machining Steel 1118, 1215, 12L14, etc.	100 - 250	450 - 800	450 - 1000	0.006 - 0.016
	Low Carbon Steel 1010, 1020, 1025, 1522, 1144, etc.	85 - 275	450 - 800	450 - 1000	0.006 - 0.016
	Medium Carbon Steel 1030, 1040, 1050, 1527, 1140, 1151, etc.	125 - 325	450 - 800	450 - 1000	0.006 - 0.016
	Alloy Steel 4140, 5140, 8640, etc.	125 - 375	450 - 800	450 - 1000	0.006 - 0.016
	High Strength Alloy 4340, 4330V, 300M, etc.	225 - 400	400 - 700	450 - 800	0.006 - 0.016
	Tool Steel H-13, H-21, A-4, O-2, 5-3, etc.	150 - 250	400 - 700	400 - 700	0.006 - 0.010
S	High Temp Alloy Hastelloy B, Inconel 600, etc.	140 - 310	100 - 250	150 - 300	0.006 - 0.010
M	Stainless Steel 400 Series 1010, 1020, 1025, 1522, 1144, etc.	185 - 350	400 - 600	400 - 700	0.006 - 0.012
	Stainless Steel 300 Series 1010, 1020, 1025, 1522, 1144, etc.	135 - 275	400 - 600	400 - 700	0.006 - 0.012
	Super Duplex Stainless Steel 1010, 1020, 1025, 1522, 1144, etc.	135 - 275	400 - 600	400 - 700	0.006 - 0.012
K	Nodular, Grey, Ductile Cast Iron	120 - 320	400 - 600	500 - 700	0.006 - 0.012
N	Cast Aluminum	30 - 180	750 - 1000	800 - 1100	0.006 - 0.016
	Wrought Aluminum	30 - 180	750 - 1000	750 - 1000	0.006 - 0.016
	Brass	100	700 - 950	750 - 1000	0.006 - 0.016

See page B20: 82 for instructions on applying the Cri-Twin boring head in different applications

NOTICE: The modular boring system's configuration, including the length of boring bar, boring head off set, and amount of extensions and/or reducers, may all affect performance of boring systems. All of these factors may increase imbalance of the modular boring system. Imbalance at excessive RPM will cause vibration in the machine tool, which can cause damage to the machine tool; in particular the spindle. This vibration may occur at spindle speeds above 1000 RPM. If vibration is present, reduce spindle speed.

Recommended Cutting Data | Metric (mm)

Rough Boring

ISO	Material	Hardness (BHN)	Cri-Twin®		Feed (mm/rev)
			M/min		
			Uncoated Inserts	Coated Inserts	
P	Free Machining Steel 1118, 1215, 12L14, etc.	100 - 250	137 - 244	137 - 305	0.15 - 0.41
	Low Carbon Steel 1010, 1020, 1025, 1522, 1144, etc.	85 - 275	137 - 244	137 - 305	0.15 - 0.41
	Medium Carbon Steel 1030, 1040, 1050, 1527, 1140, 1151, etc.	125 - 325	137 - 244	137 - 305	0.15 - 0.41
	Alloy Steel 4140, 5140, 8640, etc.	125 - 325	137 - 244	137 - 305	0.15 - 0.41
	High Strength Alloy 4340, 4330V, 300M, etc.	225 - 400	122 - 213	137 - 244	0.15 - 0.41
	Tool Steel H-13, H-21, A-4, O-2, 5-3, etc.	150 - 250	122 - 213	122 - 213	0.15 - 0.25
S	High Temp Alloy Hastelloy B, Inconel 600, etc.	140 - 310	30 - 76	46 - 91	0.15 - 0.25
M	Stainless Steel 400 Series 1010, 1020, 1025, 1522, 1144, etc.	185 - 350	122 - 182	122 - 213	0.15 - 0.31
	Stainless Steel 300 Series 1010, 1020, 1025, 1522, 1144, etc.	135 - 275	122 - 182	122 - 213	0.15 - 0.31
	Super Duplex Stainless Steel 1010, 1020, 1025, 1522, 1144, etc.	135 - 275	122 - 182	122 - 213	0.15 - 0.31
K	Nodular, Grey, Ductile Cast Iron	120 - 320	122 - 182	152 - 213	0.15 - 0.31
N	Cast Aluminum	30 - 180	220 - 305	244 - 335	0.15 - 0.41
	Wrought Aluminum	30 - 180	220 - 305	229 - 305	0.15 - 0.41
	Brass	100	213 - 290	229 - 305	0.15 - 0.41

See page B20: 82 for instructions on applying the Cri-Twin boring head in different applications

NOTICE: The modular boring system's configuration, including the length of boring bar, boring head off set, and amount of extensions and/or reducers, may all affect performance of boring systems. All of these factors may increase imbalance of the modular boring system. Imbalance at excessive RPM will cause vibration in the machine tool, which can cause damage to the machine tool; in particular the spindle. This vibration may occur at spindle speeds above 1000 RPM. If vibration is present, reduce spindle speed.

Recommended Cutting Data | Imperial (inch)

Finish Boring

ISO	Material	Hardness (BHN)	Cri-Bore® CBER® CB Style		
			SFM		Feed (IPR)
			Uncoated Inserts	Coated Inserts	
P	Free Machining Steel 1118, 1215, 12L14, etc.	100 - 250	350 - 700	450 - 800	0.003 - 0.005
	Low Carbon Steel 1010, 1020, 1025, 1522, 1144, etc.	85 - 275	350 - 700	450 - 800	0.002 - 0.004
	Medium Carbon Steel 1030, 1040, 1050, 1527, 1140, 1151, etc.	125 - 325	400 - 700	500 - 800	0.002 - 0.004
	Alloy Steel 4140, 5140, 8640, etc.	125 - 375	300 - 600	400 - 700	0.002 - 0.004
	High Strength Alloy 4340, 4330V, 300M, etc.	225 - 400	300 - 600	350 - 650	0.002 - 0.004
	Tool Steel H-13, H-21, A-4, O-2, 5-3, etc.	150 - 250	300 - 600	300 - 700	0.002 - 0.004
S	High Temp Alloy Hastelloy B, Inconel 600, etc.	140 - 310	100 - 250	150 - 300	0.002 - 0.004
M	Stainless Steel 400 Series 1010, 1020, 1025, 1522, 1144, etc.	185 - 350	350 - 600	400 - 650	0.002 - 0.004
	Stainless Steel 300 Series 1010, 1020, 1025, 1522, 1144, etc.	135 - 275	350 - 600	400 - 650	0.002 - 0.004
	Super Duplex Stainless Steel 1010, 1020, 1025, 1522, 1144, etc.	135 - 275	350 - 600	400 - 650	0.002 - 0.004
K	Nodular, Grey, Ductile Cast Iron	120 - 320	400 - 600	500 - 700	0.002 - 0.004
N	Cast Aluminum	30 - 180	750 - 1000	800 - 1100	0.002 - 0.004
	Wrought Aluminum	30 - 180	750 - 1000	750 - 1000	0.002 - 0.004
	Brass	100	700 - 950	750 - 1000	0.002 - 0.004

NOTICE: The modular boring system's configuration, including the length of boring bar, boring head off set, and amount of extensions and/or reducers, may all affect performance of boring systems. All of these factors may increase imbalance of the modular boring system. Imbalance at excessive RPM will cause vibration in the machine tool, which can cause damage to the machine tool; in particular the spindle. This vibration may occur at spindle speeds above 1000 RPM. If vibration is present, reduce spindle speed.

Recommended Cutting Data | Metric (mm)

Finish Boring

ISO	Material	Hardness (BHN)	Cri-Bore® CBER® CB Style		Feed (mm/rev)
			M/min		
			Uncoated Inserts	Coated Inserts	
P	Free Machining Steel 1118, 1215, 12L14, etc.	100 - 250	107 - 213	137 - 244	0.08 - 0.13
	Low Carbon Steel 1010, 1020, 1025, 1522, 1144, etc.	85 - 275	107 - 213	137 - 244	0.05 - 0.10
	Medium Carbon Steel 1030, 1040, 1050, 1527, 1140, 1151, etc.	125 - 325	122 - 213	152 - 244	0.05 - 0.10
	Alloy Steel 4140, 5140, 8640, etc.	125 - 325	91 - 182	122 - 213	0.05 - 0.10
	High Strength Alloy 4340, 4330V, 300M, etc.	225 - 400	91 - 182	107 - 198	0.05 - 0.10
	Tool Steel H-13, H-21, A-4, O-2, 5-3, etc.	150 - 250	91 - 182	107 - 213	0.05 - 0.10
S	High Temp Alloy Hastelloy B, Inconel 600, etc.	140 - 310	30 - 76	46 - 91	0.05 - 0.10
M	Stainless Steel 400 Series 1010, 1020, 1025, 1522, 1144, etc.	185 - 350	107 - 182	122 - 198	0.05 - 0.10
	Stainless Steel 300 Series 1010, 1020, 1025, 1522, 1144, etc.	135 - 275	107 - 182	122 - 198	0.05 - 0.10
	Super Duplex Stainless Steel 1010, 1020, 1025, 1522, 1144, etc.	135 - 275	107 - 182	122 - 198	0.05 - 0.10
K	Nodular, Grey, Ductile Cast Iron	120 - 320	122 - 182	152 - 213	0.05 - 0.10
N	Cast Aluminum	30 - 180	229 - 305	244 - 335	0.05 - 0.10
	Wrought Aluminum	30 - 180	229 - 305	229 - 305	0.05 - 0.10
	Brass	100	213 - 290	229 - 305	0.05 - 0.10

NOTICE: The modular boring system's configuration, including the length of boring bar, boring head off set, and amount of extensions and/or reducers, may all affect performance of boring systems. All of these factors may increase imbalance of the modular boring system. Imbalance at excessive RPM will cause vibration in the machine tool, which can cause damage to the machine tool; in particular the spindle. This vibration may occur at spindle speeds above 1000 RPM. If vibration is present, reduce spindle speed.

Set-up Instructions | Cri-Twin® Modular Boring Heads

Adjusting Cri-Twin Modular Boring Heads (see figure B1)

1. Loosen the insert holder locking screw (4) on the insert holder (1) to be adjusted. Re-snug lightly using light finger pressure only. Only one insert holder should be adjusted at a time. The other insert holder should remain locked.
2. Loosen and re-snug the body clamp bolt (5) so a small amount of tension is felt when adjusting the dial screw.
3. Turn the dial screw (3) clockwise to increase the diameter and counterclockwise to decrease the diameter.
4. Tighten the insert holder locking screw (4).
5. Rotate the boring head 180°.
6. Repeat steps 1, 3, and 4.
7. Tighten the body clamp bolt (5).

NOTE: To machine a smaller bore diameter, turn the dial screw (3) counterclockwise one full turn minimum to remove any backlash, and then adjust to small size.

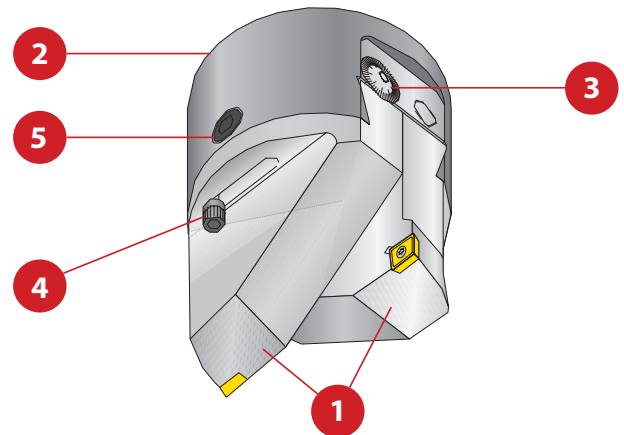

Figure B1

No.	Part
1	Insert holders
2	Boring head body
3	Dial screw
4	Insert holder locking screw
5	Body clamp bolt

Cri-Twin Modular Boring Heads

The Cri-Twin Modular Boring System is one of the most versatile boring systems available today. With a combination of insert holders, you can perform different types of boring operations. The Cri-Twin system can double your feed rate, double the material removed, or rough and finish in the same operation.

1. Double Feed Rate Operations:

This requires using two "standard length" or two "zero lead" insert holders and setting the cutting tips of both insert holders to bore the same diameter. The inserts will make equal cuts in the bore so you can double your feed rate and reduce the cycle time to bore your hole. Utilizing the Cri-Twin system in this manner may leave tool retraction marks in the finish bore. For best results, you should bore into and out of the hole.

NOTICE: Use rough boring feed recommendations from charts on pages B20: 78 - 79.

2. Double Material Removed:

This requires using a standard and a short length insert holder. The standard length insert holder enters the cut first so it needs to be set to remove one-half of the material to be bored from the hole. The short insert holder is then set to the finish bore diameter. Remember, when doubling the material removed, each cutting edge is working separately, and you should not double your feed rate.

NOTICE: Use finish boring feed recommendations from charts on pages B20: 80 - 81.

3. Roughing and Finishing:

This requires using a standard and a short length insert holder. The standard length insert holder will be set to the rough bore diameter and then the short length insert holder will be set to the finish bore diameter. Utilizing the Cri-Twin system in this manner may leave tool retraction marks in the finish bore. For best results, you should bore into and out of the hole.

NOTICE: Use finish boring feed recommendations from charts on pages B20: 80 - 81.

Set-up Instructions | Standard and Micro Adjusting Boring Heads**Adjusting Standard Adjusting Boring Heads (see figure B2)**

1. Loosen the locking screw (6).
2. Turn the dial screw (3) clockwise to increase the diameter, and turn it counterclockwise to decrease the diameter.
3. Tighten the locking screw (6).

IMPORTANT: Do not loosen the gib screws (5). It can cause poor performance when making diameter adjustments.

NOTE: To machine a smaller bore diameter, turn the dial screw (3) counterclockwise one full turn minimum to remove any backlash, and then adjust to small size.

No.	Part
1	Bar holder
2	Boring head body
3	Dial screw
4	Bar holder set screws
5	Gib screws
6	Locking screw

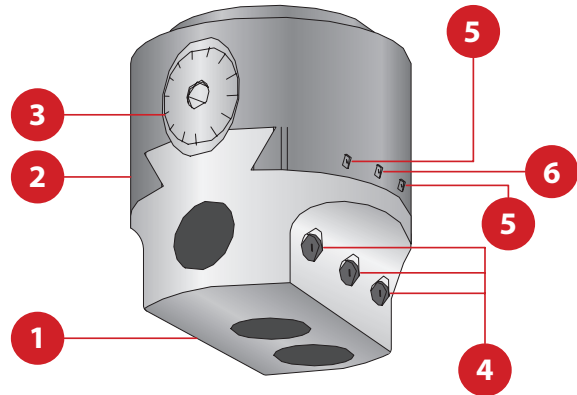

Figure B2

Adjusting Micro Adjusting Setting Boring Heads (see figure B3)

Before setting the micro adjusting boring head to the bore diameter, you need to set the micro adjusting dial (7) to the minimum bore diameter.

1. Turn the micro adjusting dial (7) clockwise until the dial screw bottoms out on the bottom of the dial screw bore.
2. Note the graduation line on the dial face closest to the reference line, then turn the micro adjusting dial (7) counterclockwise 3-1/4 turns.
3. Reverse direction and line the graduation line noted in Step 2 with the reference line.
4. The micro adjusting dial is now set so you have 0.006" on diameter of adjustment.

Adjusting micro adjusting setting boring heads is just as easy as adjusting standard boring heads. First, you adjust the boring head using the 0.001" adjustment (3), and then you make your final adjustment with the 0.00005" adjustment (7).

1. Loosen the locking screw (6).
2. Turn the dial screw (3) clockwise to increase the diameter and counterclockwise to decrease the diameter.
3. Tighten the locking screw (6).
4. Turn the 0.00005" dial screw (7) clockwise to increase the diameter and counterclockwise to decrease the diameter. Locking of the 0.00005" dial screw (7) is **not** required.

NOTE: The micro adjusting dial screws only have a total range of 0.006" (0.15mm) on diameter.

No.	Part
1	Insert holder
2	Boring head body
3	Dial screw
4	Gib screws
5	Locking screw
6	Micro adjusting dial screw

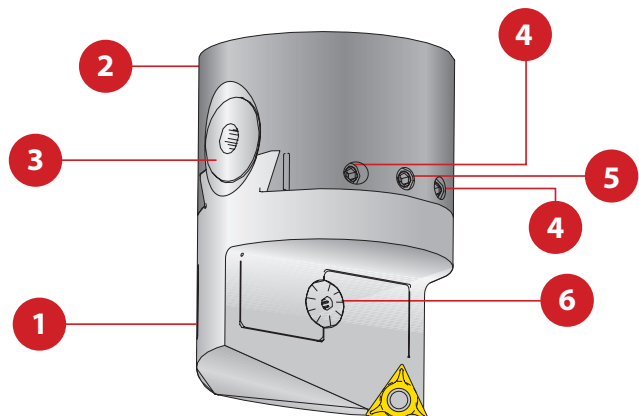

Figure B3

Set-up Instructions | Manual Boring and Facing Heads

For General Boring (see figure B4)

When no lateral movement is required, the Manual Boring and Facing head can be used for standard boring operations. Adjustments are made by placing a hex wrench in the end of the dial screw (6) and dialing off the required amount. Each graduation on the dial represents 0.001" on the bore diameter.

1. Loosen the locking screw (10).
2. Turn the dial screw (6) clockwise to increase the diameter and counterclockwise to decrease the diameter.
3. Tighten the locking screw (10).
4. To readjust for the next cut, repeat steps 1, 2, and 3.

NOTE: To machine a smaller bore diameter, turn dial screw (6) counterclockwise one full turn minimum to remove any backlash and then adjust to smaller size.

For Facing in the Reverse Direction

The Manual Boring & Facing Head is capable of reverse feed by running the spindle in reverse. To set the head for feeding in clockwise and counterclockwise direction, screw the head on the desired shank.

1. Align the "Rev. Lock" mark on the facing ring (7) with the "Rev. Lock" mark on the body (5) (see Figure B5).
2. Insert a 3/32" hex wrench through the hole in the facing ring (7) and tighten the reversing lock screw (15) (see Figure B6) in the top cap (14). This prevents the head from unscrewing during reverse (counterclockwise) operation.

NOTICE: To run the spindle in reverse, the head must be locked onto the shank. Please follow the directions above carefully.

For Facing, Grooving, and Undercutting

Set-up instructions:

1. Make sure the dial screw lock (12) is loose.
2. Insert a hex wrench in the dial screw (6) and position the tool at the start of the cut. To simplify a return to this position, set left* dog stop (2) against the stop pin (3).
3. Determine the length of cut required and with the aid of a gauge block, set the right* dog stop (4) against the stop pin (3).
4. Remove gauge block and lower the spindle to the proper depth.
5. Tighten the locking screw (12).
6. As the spindle turns, hold on to the facing ring (7). The tool will feed out at the rate of 0.003 per revolution (fine feed, 0.0015) until the right* dog stop (4) strikes the stop pin. At this point, the clutch will disengage. Although the facing ring (7) will continue to revolve, the tool will not advance.
7. For fine adjustments: after setting for facing mode with gauge block, the fine adjusting screws (13) may be utilized to aid in the adjustment of the dog stops (2) and (4).
8. To return the tool to the starting position, place a hex wrench in the dial screw (6) and turn counterclockwise until left* dog stop (2) contacts the stop pin (3) or (see note below) while holding onto the facing ring (7), reverse the spindle and the tool will go back to the starting position.

NOTICE: While machining either right or left hand, the bar holder (1) should never extend past the body (5) on the dial screw face side. This would result in tool damage due to the boring head rubbing inside of the bored hole.

* Instructions are based on right hand cutting. If the application requires left hand cutting, reverse the dog stop instructions listed above.

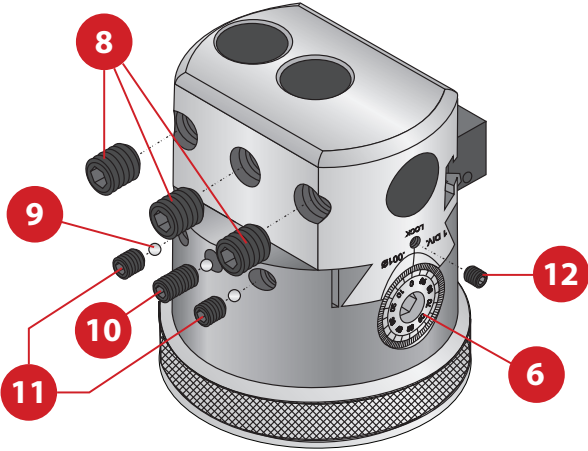

Figure B4

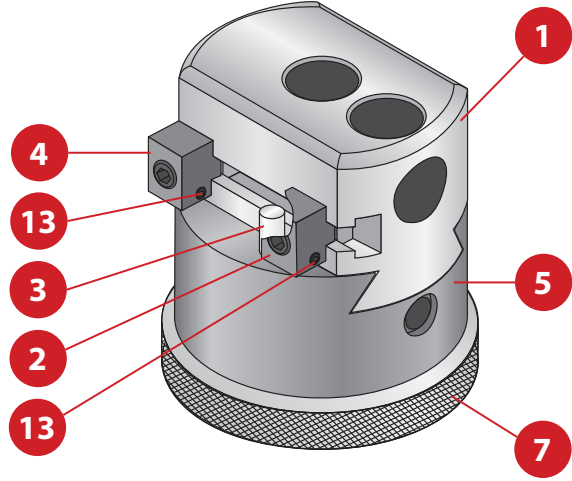

Figure B5

No.	Part	No.	Part
1	Bar holder	9	Steel balls
2	Left dog stop	10	Locking screw
3	Stop pin	11	Gib screws
4	Right dog stop	12	Dial screw lock
5	Body	13	Fine adjusting screws
6	Dial screw	14	Top cap
7	Facing ring	15	Reversing lock screw
8	Bar holder set screws		

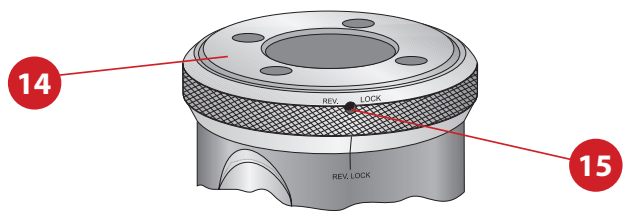

Figure B6

Set-up Instructions | CNC Boring and Facing Heads

For CNC Operations - Horizontal or Vertical

To set the head for CNC tool change operations, first refer to the "For Facing, Grooving, and Undercutting" and "For Facing in the Reverse Direction" instructions on page B20: 84 and set the gib, stop dogs, and thread lock as described.

1. Install the head in the machine spindle and ensure the spindle is in its "home" or "tool change" position. Take note of the position of the anti-rotation device on your machine in relation to the key slot in the taper shank. Then remove the head from the machine.
2. Using the two #10-32 cap screws supplied, attach the plunger housing (16) to the facing ring (7). Note that the lock ring (18) should be loose and turn freely.
3. Align the 1/8" dowel pin in the plunger (17) with the slot in the lock ring (18).
4. Attach the stop arm (19) to the plunger (17) using the #10-32 button head screw provided. At this time, the facing ring (7) should turn with slight resistance.
5. Rotate the facing ring (7) so that the stop arm (19) is in the approximate position relative to the key slot in the taper shank.
6. Install the head in the spindle, taking care to set the stop arm (19) in its proper position relative to the anti-rotation device on the machine.
7. With the head in the machine's spindle at its "home" or "tool change" position, clamp the lock ring clamps (20) in position using the two #4-40 set screws on the periphery of the lock ring (18). The head is now ready for use.

IMPORTANT: Stop arm is required.

Calculating Dwell Time: $T = (D / 0.0015) / (RPM / 60)$

Where:

- RPM = spindle speed
- 60 = seconds
- D = distance from the dog stop to the stop pin
- 0.0015 = radial feed per revolution (inches)
- T = dwell time (seconds)

Example:

The cut is 0.500" change in diameter. The radial distance (the distance the dog stop is away from the stop pin) is 0.250". This is your D. The spindle speed is determined to be 500 RPM. Therefore, the formula is now:

$$T = (0.250 / 0.0015) / (500 / 60)$$

$$T = 20 \text{ seconds}$$

NOTICE: Damage to the Boring & Facing head's clutch and gear mechanism may result if operated above 700 RPM. Because the head is not connected to, or controlled by, the machine's CNC control, allowances must be made in the machine's program to allow the head enough time to make its cut (and return). To accomplish this, a dwell must be inserted in the program. To calculate the dwell time, use the following formula.

As a matter of practice, the dwell time will almost always be a few seconds longer than "T" to allow the head to come firmly against the stop and force the clutch to slip. This will allow the tool to come to a constant size (spring cut). This may take some test cuts to determine the necessary additional time.

Use the information above to face a bottom bore and cut an internal relief groove. Call up the head in the CNC program. **DO NOT START THE SPINDLE.** Center the head over the bore to enter. Enter the holder in Z axis so that the groove tool is properly placed to begin cutting. In the program, set the RPM to be 500 as calculated from example. **NOW START THE SPINDLE** and set a dwell time of 22 seconds. At the end of this dwell, stop the spindle and set another dwell time of 22 seconds. At the end of this dwell, stop the spindle and retract the head. You now have a faced surface with an undercut.

If the tool is free of cutting on the return stroke, the head may be increased to the maximum of 700 RPM to speed the return as long as the dwell time is reduced accordingly so as not to slip the clutch unnecessarily. Excessive dwell time has the effect of "impact hammering" the feed mechanism against the dog stop and should be avoided.

No.	Part
7	Facing ring
16	Plunger housing
17	Plunger
18	Lock ring
19	Stop arm
20	Lock ring clamps

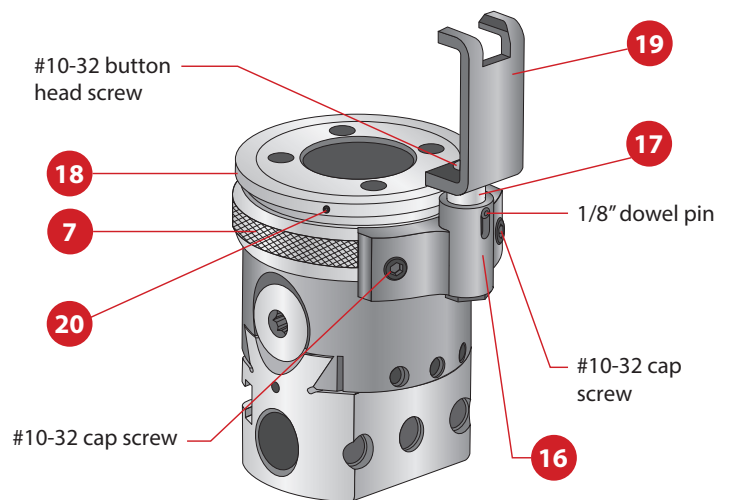

Figure B7

Guaranteed Test / Demo Application Form

Distributor PO #	
------------------	--

The following must be filled out completely before your test will be considered

Distributor Information

Company Name: _____
 Contact: _____
 Account Number: _____
 Phone: _____
 Email: _____

End User Information

Company Name: _____
 Contact: _____
 Industry: _____
 Phone: _____
 Email: _____

Current Process List all tooling, coatings, substrates, speeds and feeds, tool life, and any problems you are experiencing

Test Objective List what would make this a successful test (i.e. penetration rate, finish, tool life, hole size, etc.)

Application Information

Finish Bore Diameter: _____ in/mm	Tolerance: _____	Material: _____ (4150 / A36 / Cast Iron / etc.)
Pre-existing Diameter: _____ in/mm	Depth of Bore: _____ in/mm	Hardness: _____ (BHN / Rc)
		State: _____ (Casting / Hot rolled / Forging)

Machine Information

Machine Type: _____ (Lathe / Screw machine / Machine center / etc.)	Builder: _____ (Haas, Mori Seiki, etc.)	Model #: _____
Shank Required: _____ (CAT50 / Morse taper, etc.)		Power: _____ HP/KW
Rigidity: _____	Orientation: _____	Tool Rotating: _____
<input type="checkbox"/> Excellent	<input type="checkbox"/> Vertical	<input type="checkbox"/> Yes
<input type="checkbox"/> Good	<input type="checkbox"/> Horizontal	<input type="checkbox"/> No
<input type="checkbox"/> Poor		
	Using Canned Boring Cycle	Thrust: _____ lbs/N
	<input type="checkbox"/> Yes	
	<input type="checkbox"/> No	

Coolant Information

Coolant Delivery: _____ (Through tool / Flood)	Coolant Pressure: _____ PSI / bar
Coolant Type: _____ (Air mist, oil, synthetic, water soluble, etc.)	Coolant Volume: _____ GPM / LPM

Requested Tooling

QTY	Item Number	QTY	Item Number



ALLIED MACHINE & ENGINEERING

Allied Machine & Engineering
 120 Deeds Drive
 Dover, OH 44622

Telephone: (330) 343-4283
 Toll Free USA & Canada: (800) 321-5537
 Fax: (330) 602-3400

Warranty Information

Allied Machine & Engineering warrants to original equipment manufacturers, distributors, industrial and commercial users of its products that each new product manufactured or supplied by Allied Machine shall be free from defects in material and workmanship.

Allied Machine's obligation under this warranty is limited to furnishing without additional charge a replacement or, at its option repairing or issuing credit for any product which shall within one year from the date of sale be returned freight prepaid to the plant designated by an Allied Machine representative and which upon inspection is determined by Allied Machine to be defective in materials or workmanship.

Complete information as to operating conditions, machine, set-up, and application of cutting fluid should accompany any product returned for inspection. The provisions of this warranty shall not apply to any Allied Machine products which have been subjected to misuse, improper operating conditions, machine set-up or application of cutting fluid or which have been repaired or altered if such repair or alteration in the judgment of Allied Machine would adversely affect performance of the product.

THIS WARRANTY IS IN LIEU OF ALL OTHER WARRANTIES, EXPRESS OR IMPLIED, INCLUDING ANY IMPLIED WARRANTY OF MERCHANTABILITY OR FITNESS FOR A PARTICULAR PURPOSE. Allied Machine shall have no liability or responsibility on any claim of any kind, whether in contract, tort or otherwise, for any loss or damage arising out of, connected with, or resulting from the manufacture, sale, delivery or use of any product sold hereunder, in excess of the cost of replacement or repair as provided herein.

ALL PRICES, DELIVERIES, DESIGNS, AND MATERIALS ARE SUBJECT TO CHANGE WITHOUT NOTICE.



Allied Machine & Engineering
Registered to ISO 9001
10001329

United States

Allied Machine & Engineering

120 Deeds Drive
Dover OH 44622
United States

Phone:
+1.330.343.4283

Fax:
+1.330.602.3400

Toll Free USA and Canada:
800.321.5537

Toll Free USA and Canada:
800.223.5140

Allied Machine & Engineering

485 W Third Street
Dover OH 44622
United States

Phone:
+1.330.343.4283

Fax:
+1.330.364.7666
(Engineering Dept.)

Toll Free USA and Canada:
800.321.5537

Europe

Allied Machine & Engineering Co. (Europe) Ltd.

93 Vantage Point
Pensnett Estate
Kingswinford
West Midlands
DY6 7FR England

Phone:
+44 (0) 1384.400900

Wohlhaupter GmbH

Maybachstrasse 4
Postfach 1264
72636 Frickenhausen
Germany

Phone:
+49 (0) 7022.408.0

Fax:
+49 (0) 7022.408.212

Asia

Wohlhaupter India Pvt. Ltd.

B-23, 2nd Floor
B Block Community Centre
Janakpuri, New Delhi - 110058
India

Phone:
+91 (0) 11.41827044

Your local Allied Machine representative:



www.alliedmachine.com

Allied Machine & Engineering is registered by DQS to ISO 9001 10001329

© 2018 Allied Machine & Engineering
Literature Order Number: B20-CRT
Publish Date: June 2018